

CRANBORNE STONE

ARCHITECTURAL & GARDEN ORNAMENT

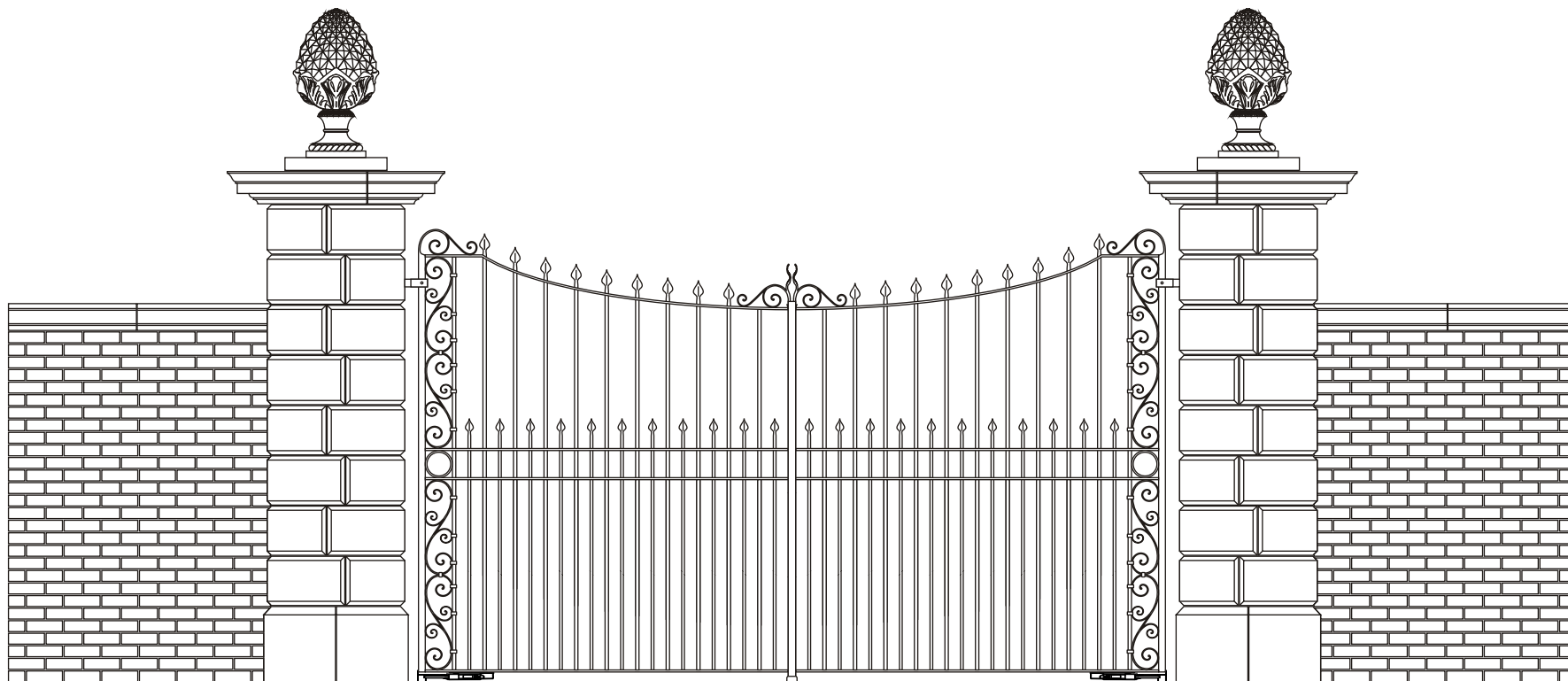

WALLS, PIERS AND FINIALS

Walls, Piers and Finials: Contents.

| | page |
|----------------------------------|------|
| Introduction | 4.1 |
| Balls and bases | 4.2 |
| Obelisks and pedestals | 4.4 |
| Pier caps: flat topped | 4.5 |
| Pier caps: weathered | 4.7 |
| Pier cap and finial combinations | 4.10 |
| Gate piers | 4.13 |
| Wall copings | 4.17 |
| Gothic wall | 4.21 |
| Appendix - product details | 4.22 |

Walls, Piers and Finials: Introduction

Material

All items are cast by hand in reconstituted stone using the dry cast method. Casts are porous unless treated and frost proof.

Colour

Casts are available in five standard finishes: Portland White, Bath Yellow, Cotswold, York, and Devon Red. All finishes age naturally taking on, over time, the patina of the surrounding lichens and mosses. A wide range of other colours and shades are available at a small additional cost.

Availability

Most architectural items are cast to order. Availability and delivery cost will be noted in all quotations.

Quotations

Please ask for a quotation - we can almost always return a firm quotation on the same day indicating price, delivery cost and availability.

Assembly

Gate piers and pedestals should be placed on a level footing of 8:1 sand to cement. Gate piers are hollow and will require reinforcements to support gates.

Prices and terms

All prices exclude VAT and delivery and are valid to 01/01/10. With the exception of account customers, or by prior agreement, payment is expected in full with each order.

Weights

All weights are approximate. Pier caps larger than 20" are partially hollow and the weights indicated are maximum weights.

Delivery

Delivery can be arranged to all destinations - including overseas destinations. Please ask for a quotation.

Bespoke work

Cranborne Stone has extensive experience of realising bespoke designs quickly and economically - please ask for a quotation.

Balls and Bases. 9" and 12" Balls.

Scale 1:10

9" ball (F090) on ...

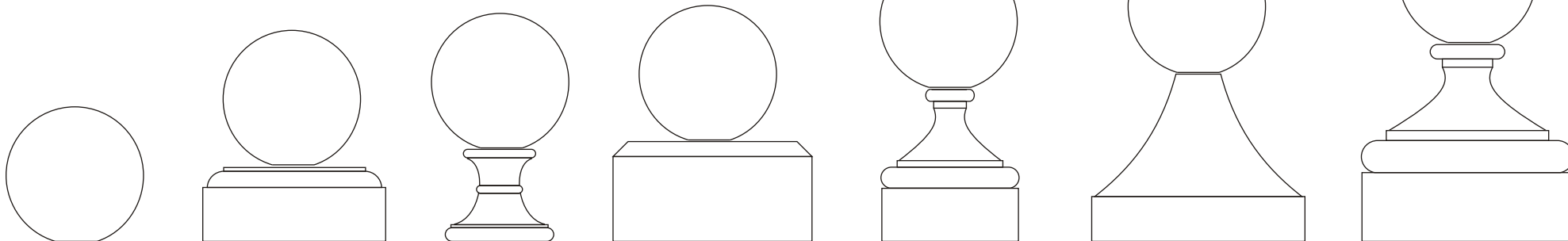

9" ball only F090
Width 229mm
Height 229mm
£35.57 12 Kg

Plinth UP06P
Plinth width 303mm
Plinth height 122mm
£25.53 20Kg

Round base F092
Base width 178mm
Base height 152mm
£22.47 4kg

Chamfered block UP11
Base width 330mm
Base height 165mm
£25.53 32Kg

Square base 9" F121
Base width 229mm
Base height 254mm
£21.53 16Kg

Sloping base F093
Base width 356mm
Base height 279mm
£24.34 28Kg

Square base 14" F171
Base width 356mm
Base height 330mm
£46.81 32Kg

12" ball (F120) on ...

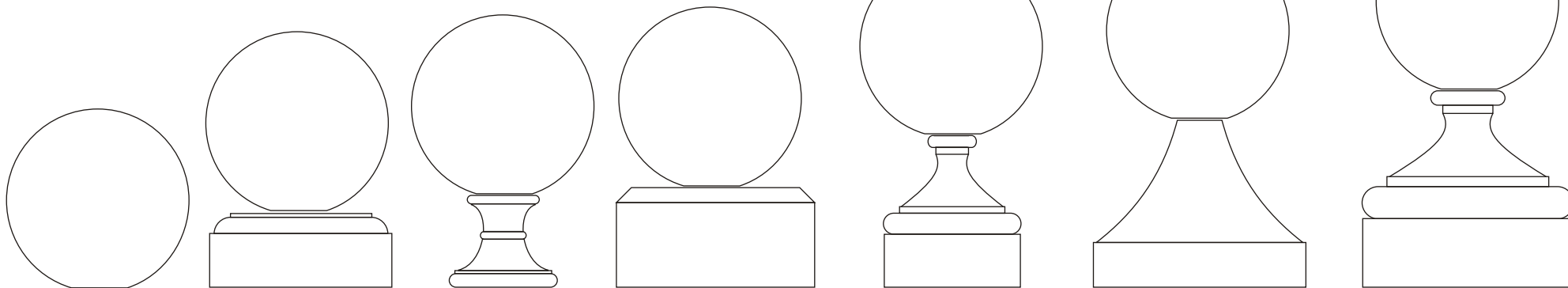

12" ball only F120
Width 305mm
Height 301mm
£52.85 30 Kg

Plinth UP06P
Plinth width 303mm
Plinth height 122mm
£25.53 20Kg

Round base F092
Base width 178mm
Base height 152mm
£22.47 4Kg

Chamfered block UP11
Base width 330mm
Base height 165mm
£25.53 32Kg

Square base 9" F121
Base width 229mm
Base height 254mm
£21.53 16Kg

Sloping base F093
Base width 356mm
Base height 279mm
£24.34 28Kg

Square base 13" F171
Base width 356mm
Base height 330mm
£46.81 32Kg

Prices valid until 01/01/10

17" Ball and Pineapple

Scale 1:10

17" ball (F170) on ...

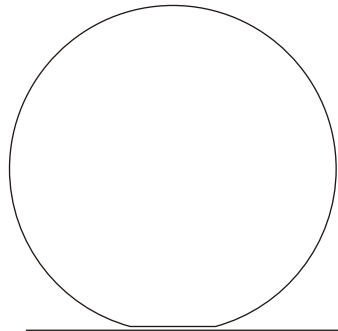

17" ball only F170
Width 432mm
Height 432mm
£93.96 80 Kg

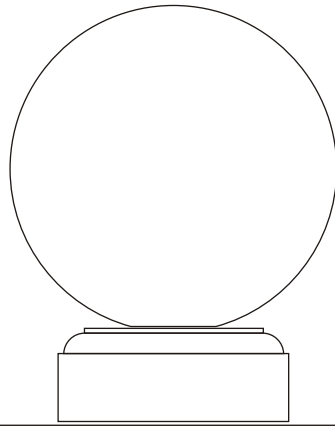

Plinth UP06P
Plinth width 303mm
Plinth height 122mm
£25.53 20Kg

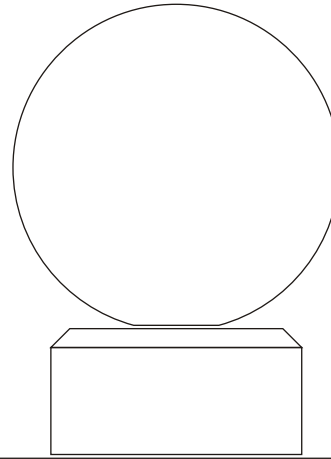

Chamfered block UP11
Base width 330mm
Base height 165mm
£25.53 32Kg

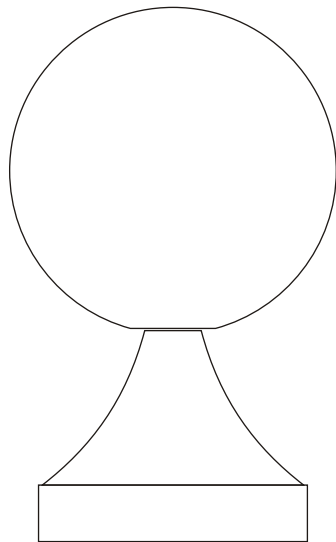

Sloping base F093
Base width 356mm
Base height 279mm
£24.34 28Kg

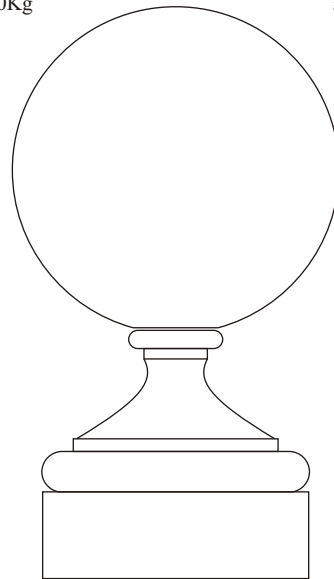

Square base 14" F171
Base width 356mm
Base height 330mm
£46.81 32Kg

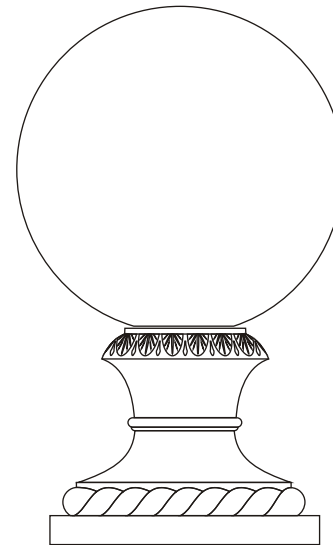

Rope pattern base F002B
Base width 356mm
Base height 277mm
£51.06 24Kg

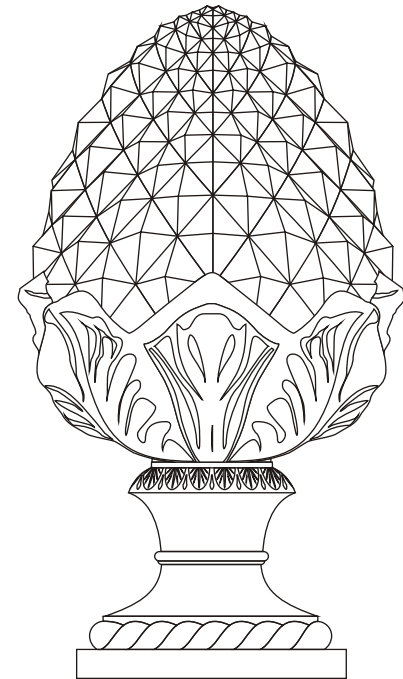

Pineapple and Base F002
£194.04 104Kg
Overall height 889mm
Base width 330mm
Maximum width 508mm

Prices valid until 01/01/10

Obelisks and Pedestals.

Scale 1:20

Obelisk F001 only:
 £97.02 64Kg
 Height 1,105mm

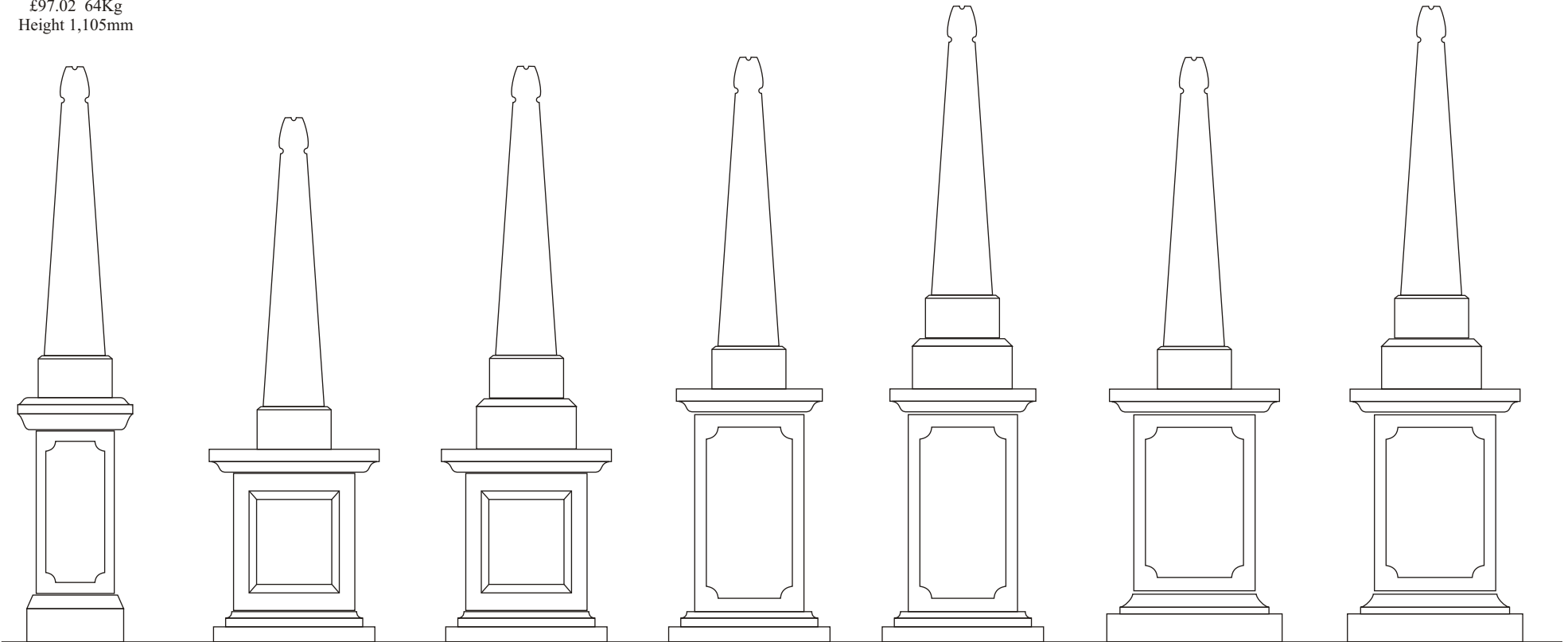

Obelisk F001 on
 Georgian Pedestal UP07
 £214.47 160Kg
 Overall height 1,918mm

Obelisk F001 on
 Panelled Pedestal UP04
 £219.57 160Kg
 Overall height 1,740mm

Obelisk F001 on
 Chamfered Block UP11 &
 Panelled Pedestal UP04
 £245.10 192Kg
 Height 1,905mm

Obelisk F001 on
 French Pedestal UP08
 £250.21 176Kg
 Overall height 1,943mm

Obelisk F001 on
 Chamfered Block UP11 &
 French Pedestal UP08
 £275.74 208Kg
 Overall height 2,108mm

Obelisk F001 on
 Victorian Pedestal UP09
 £275.74 224Kg
 Overall height 1,943mm

Obelisk F001 on
 Chamfered Block UP11 &
 Victorian Pedestal UP09
 £301.27 256Kg
 Overall height 2,108mm

Prices valid until 01/01/10

Pier Caps: Flat Topped.

Scale 1:10

Flat topped - plain

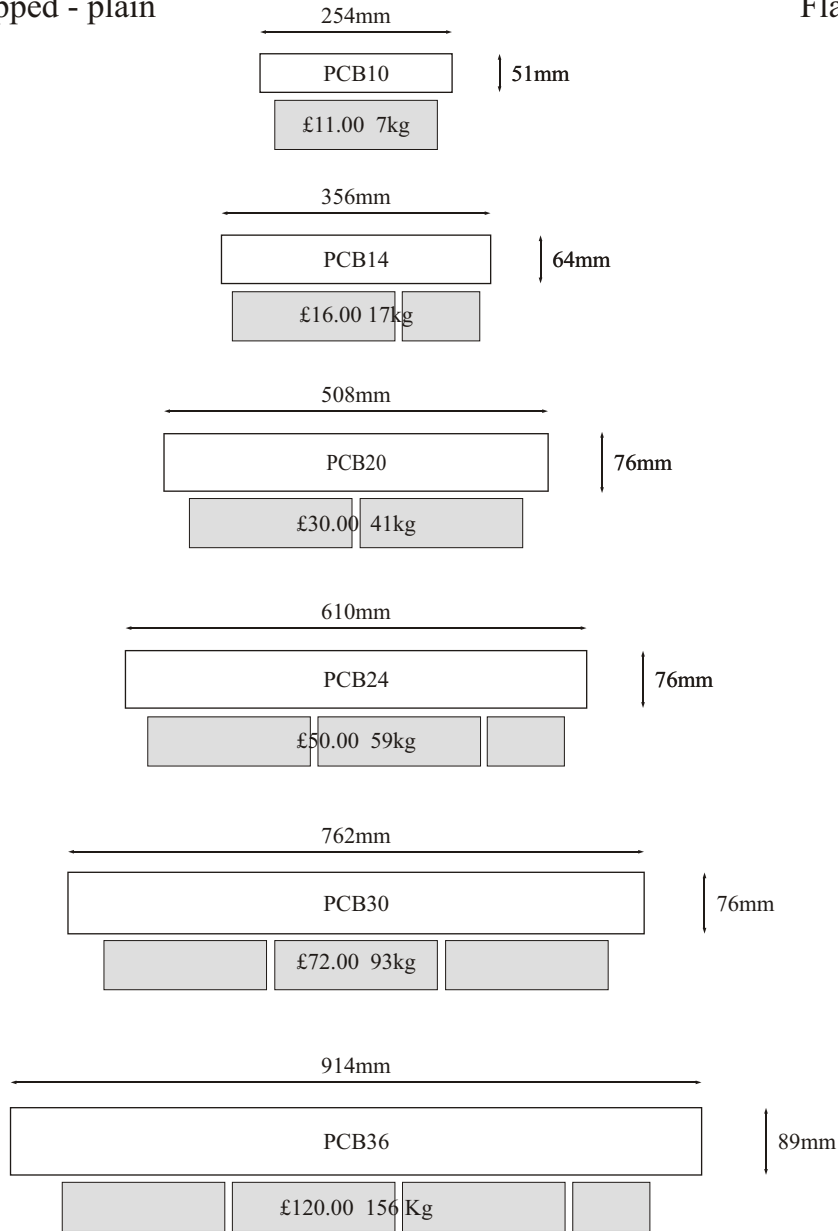

Flat topped - part weathered

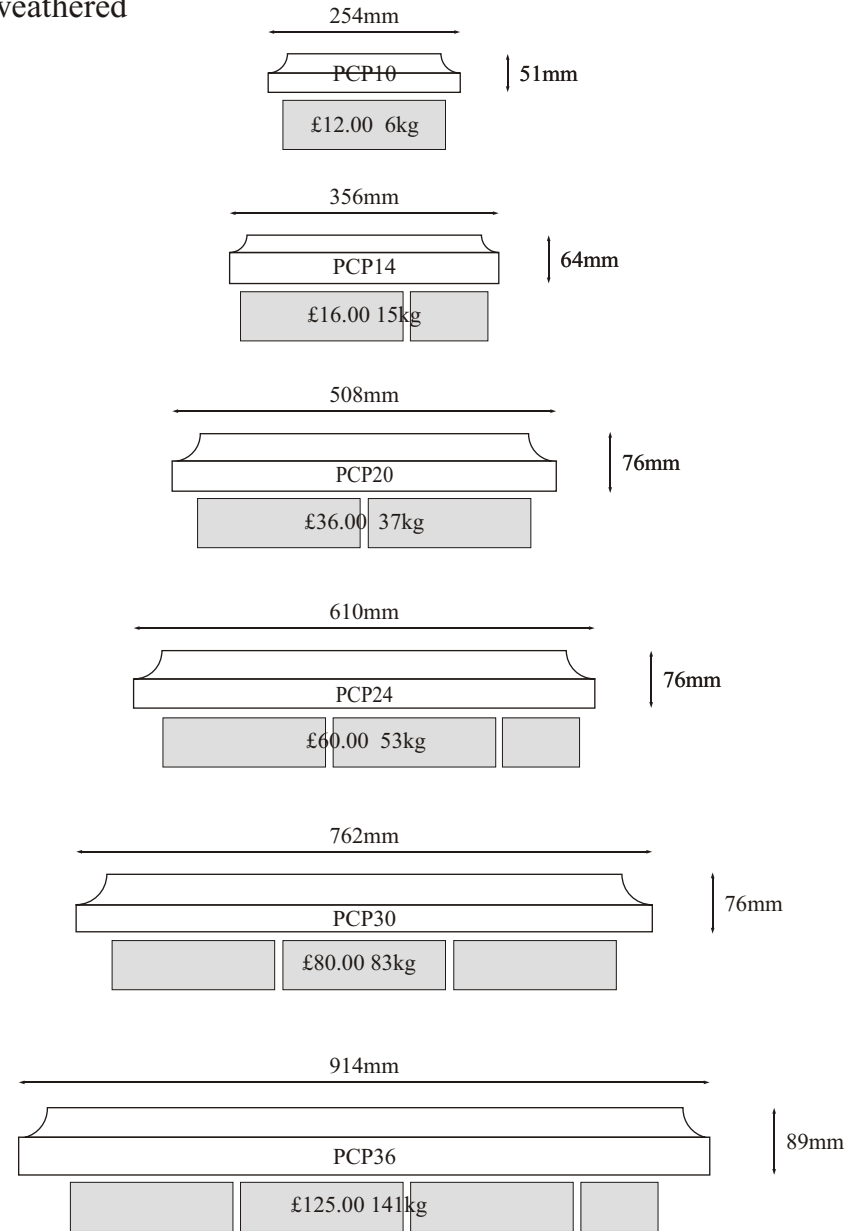

Allow 25-35mm (min) overhang, on each side, for drip channels Prices valid until 01/01/10

Pier Caps: Flat Topped - Decorated.

Scale 1:10

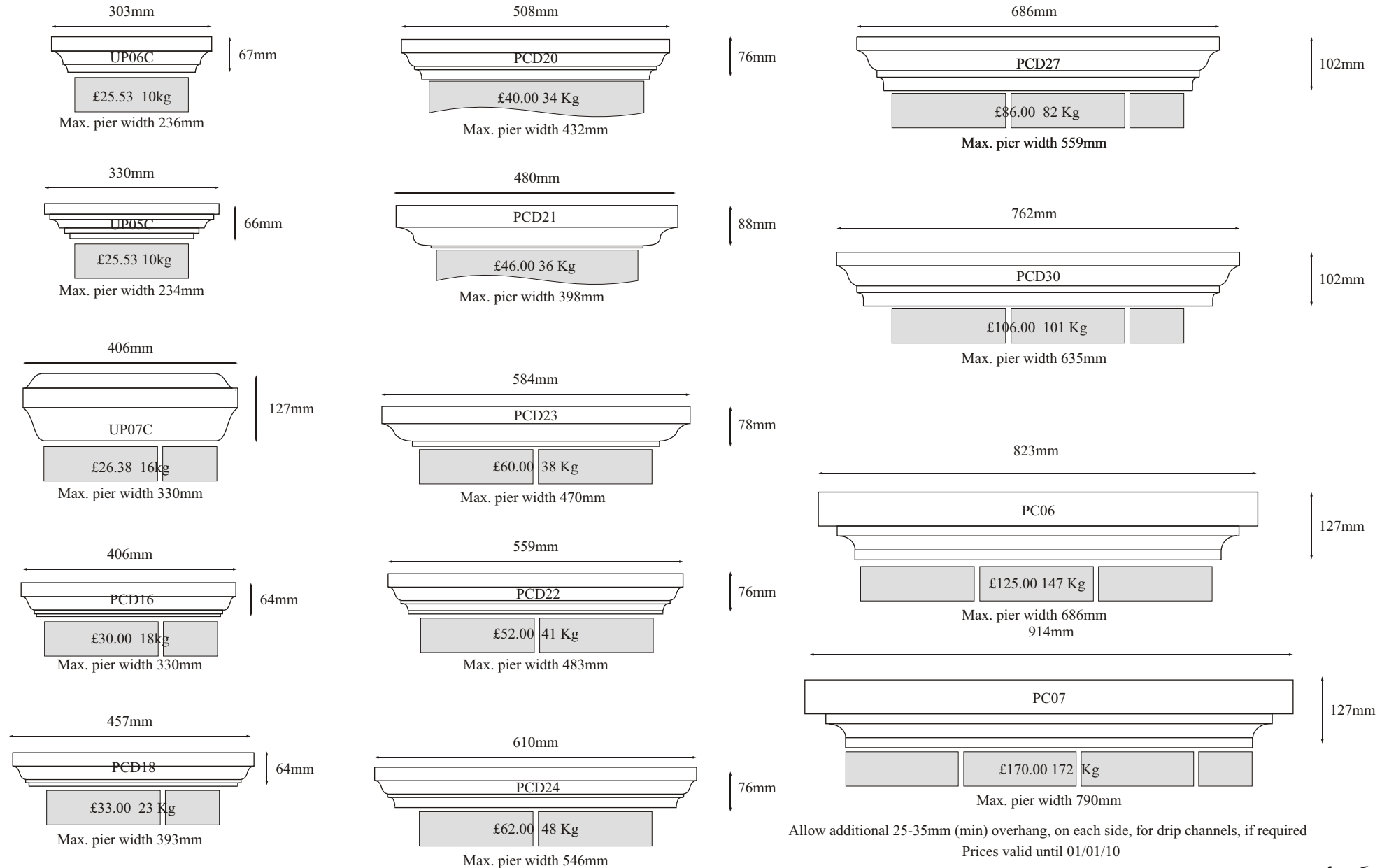

Pier Caps: Weathered Plain.

Scale 1:10

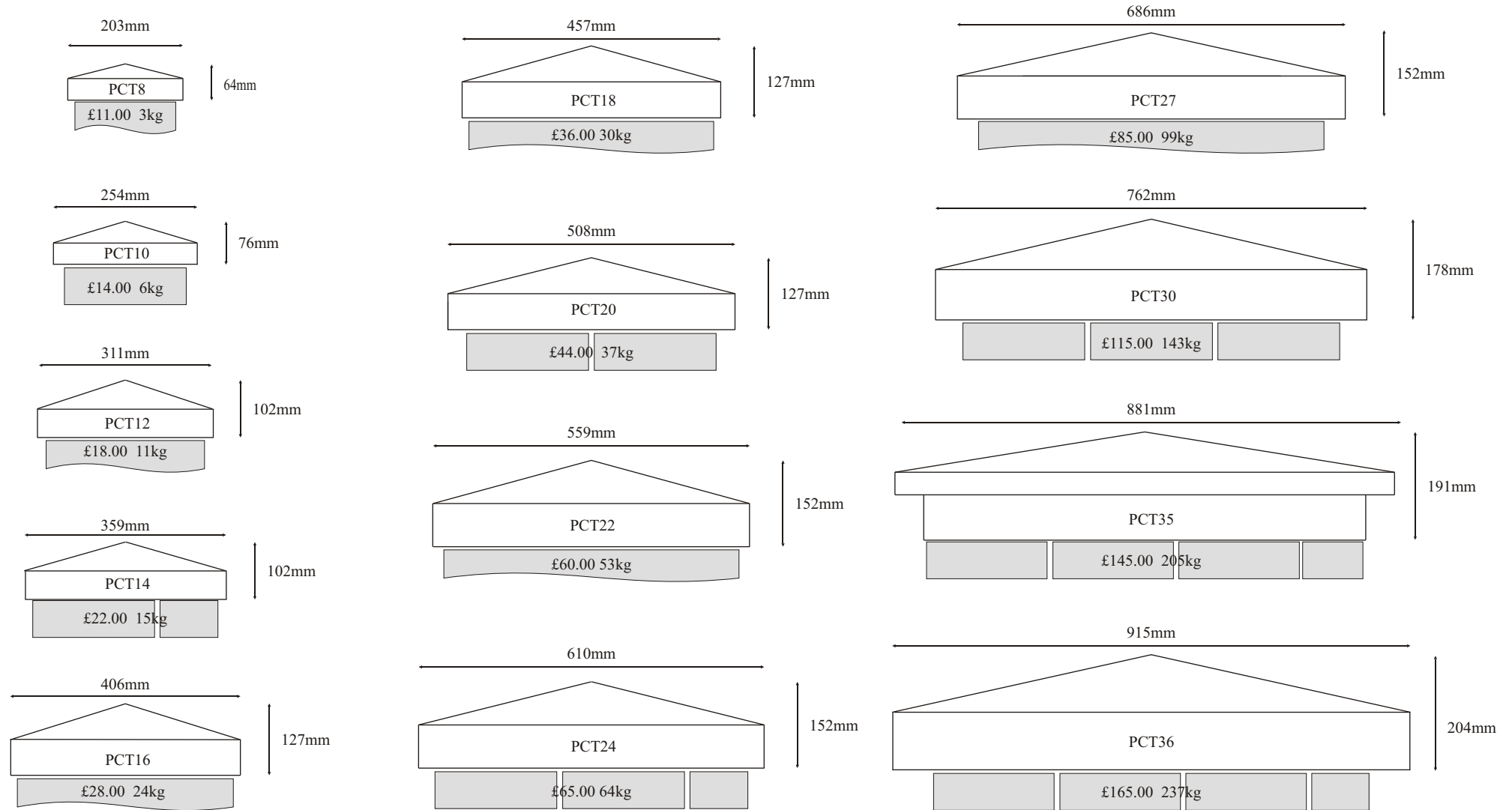

Allow 25-35mm (min) overhang, on each side, for drip channels

And PCT37 max. width 940 mm

Prices valid until 01/01/10

Pier Caps: Weathered Decorated.

Scale 1:10

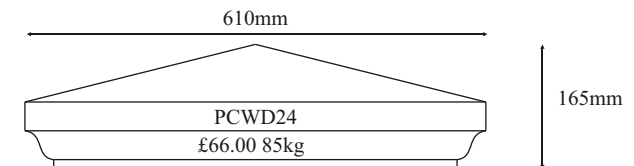
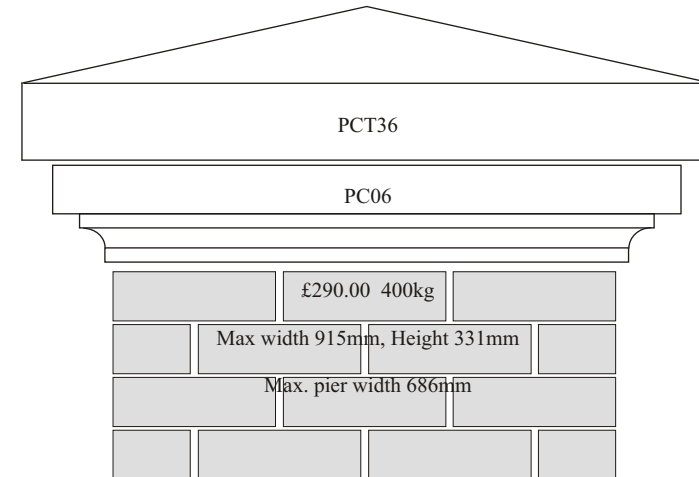
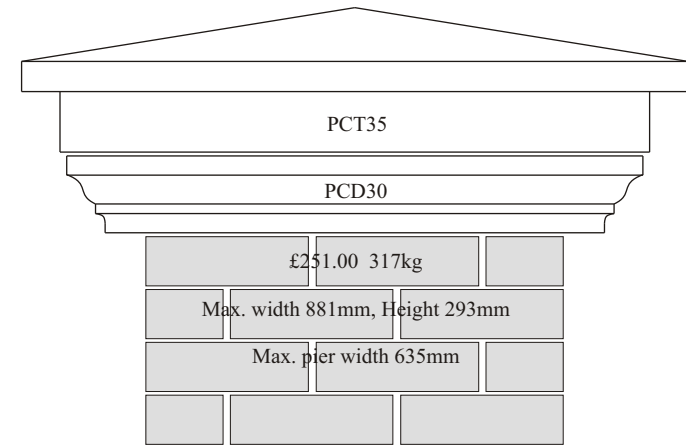
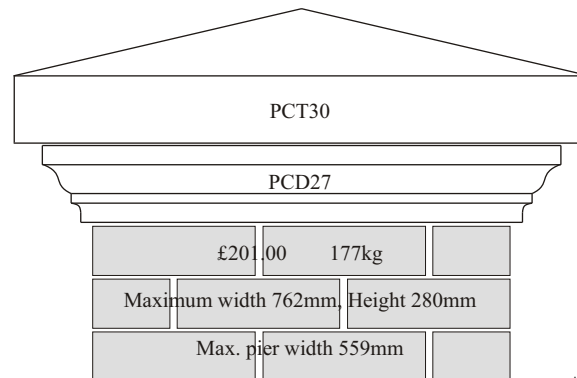
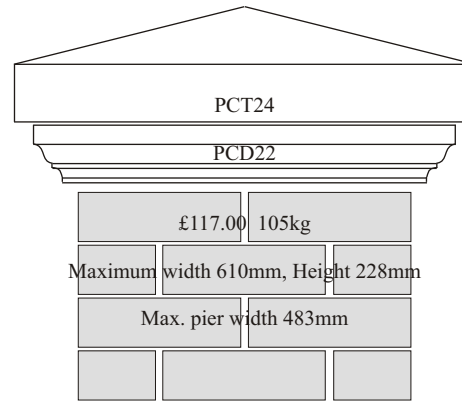
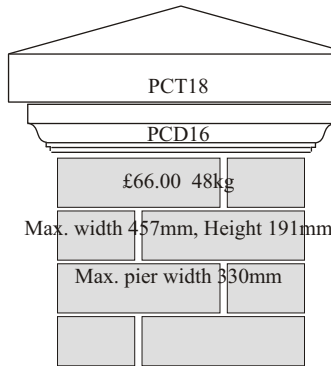
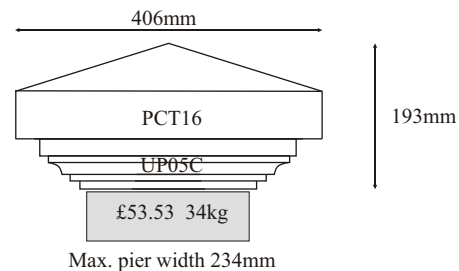
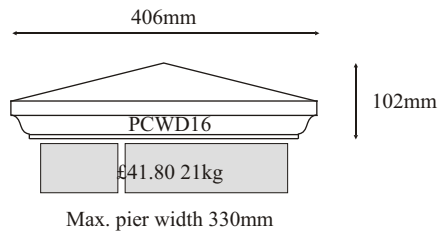
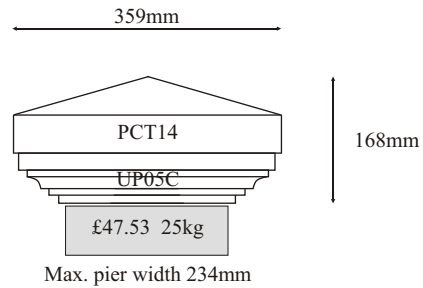
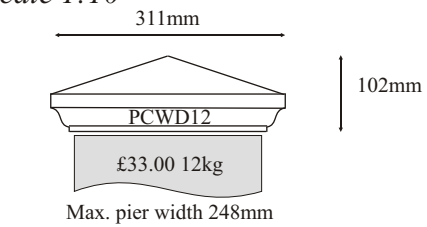

Allow additional 25-35mm (min) overhang, on each side, for drip channels, if required
 Prices valid until 01/01/10

Pier Caps: Half Weathered.

Scale 1:10

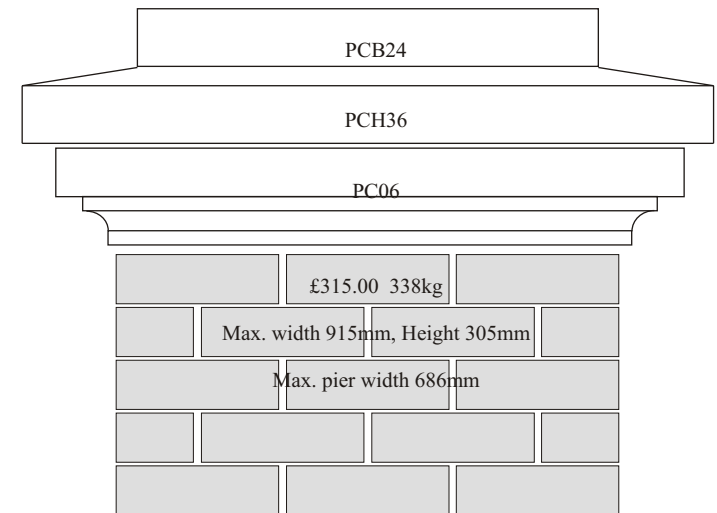
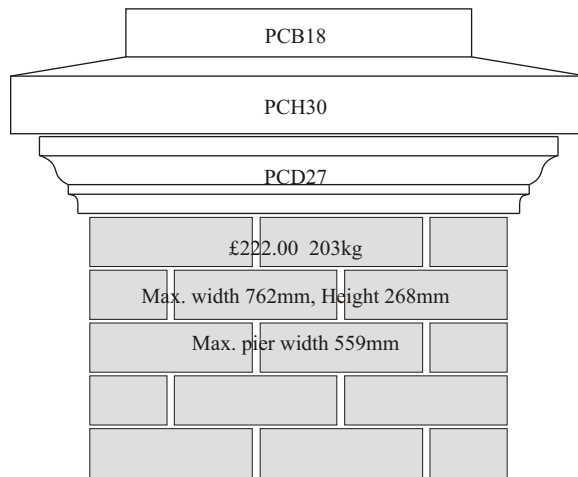
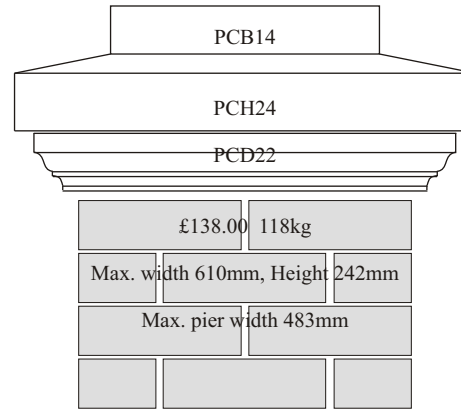
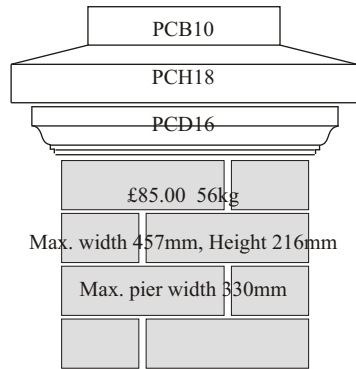

Allow additional 25-35mm (min) overhang, on each side, for drip channels, if required

Prices valid until 01/01/10

Pier Cap and Finial Combinations (440mm Pier).

Scale 1:10

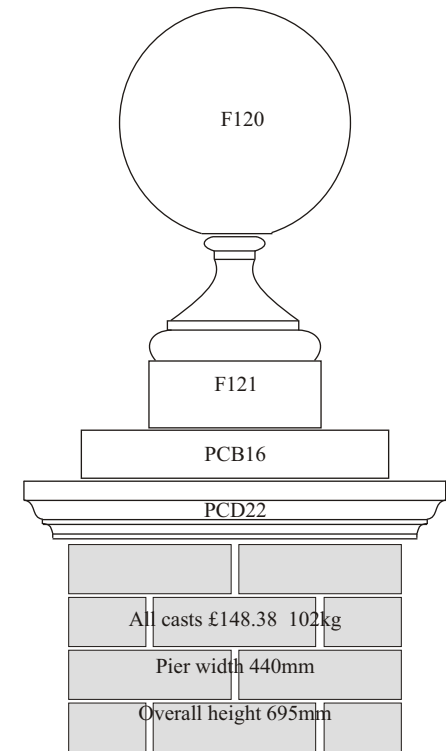
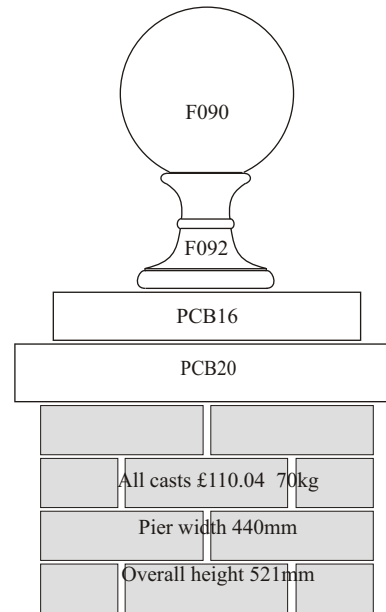
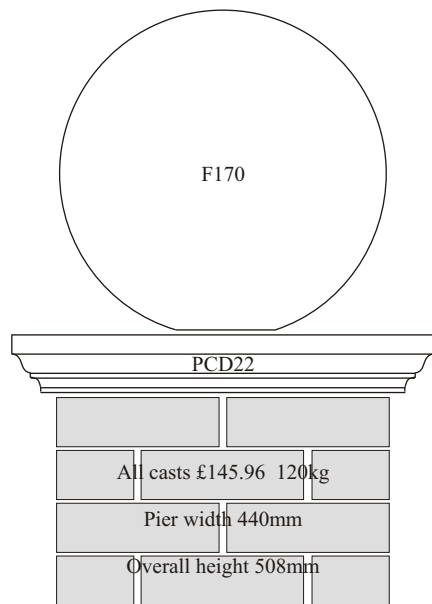

Prices valid until 01/01/10

Pier Cap and Finial Combinations (552mm Pier).

Scale 1:10

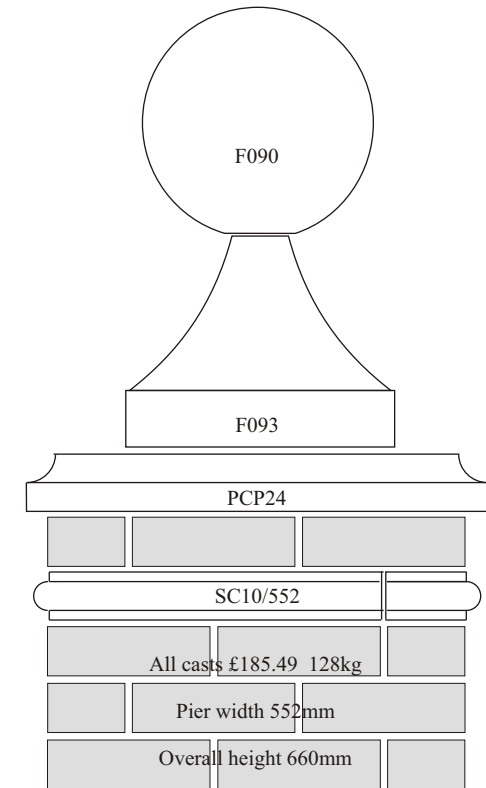
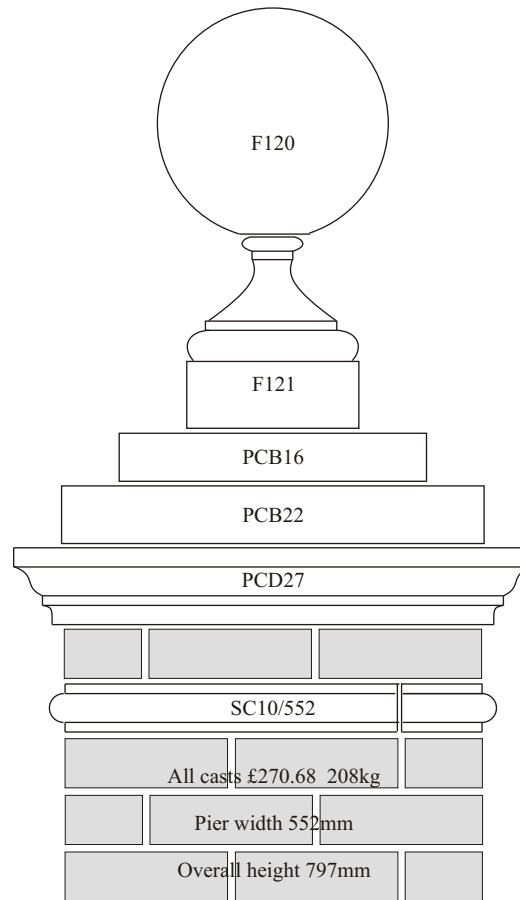
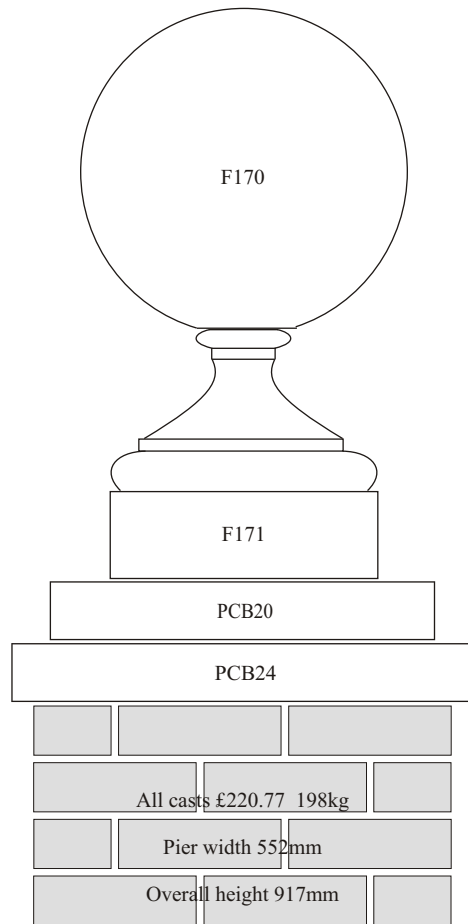

Prices valid until 01/01/10

Pier Cap and Finial Combinations (665mm Pier).

Scale 1:10

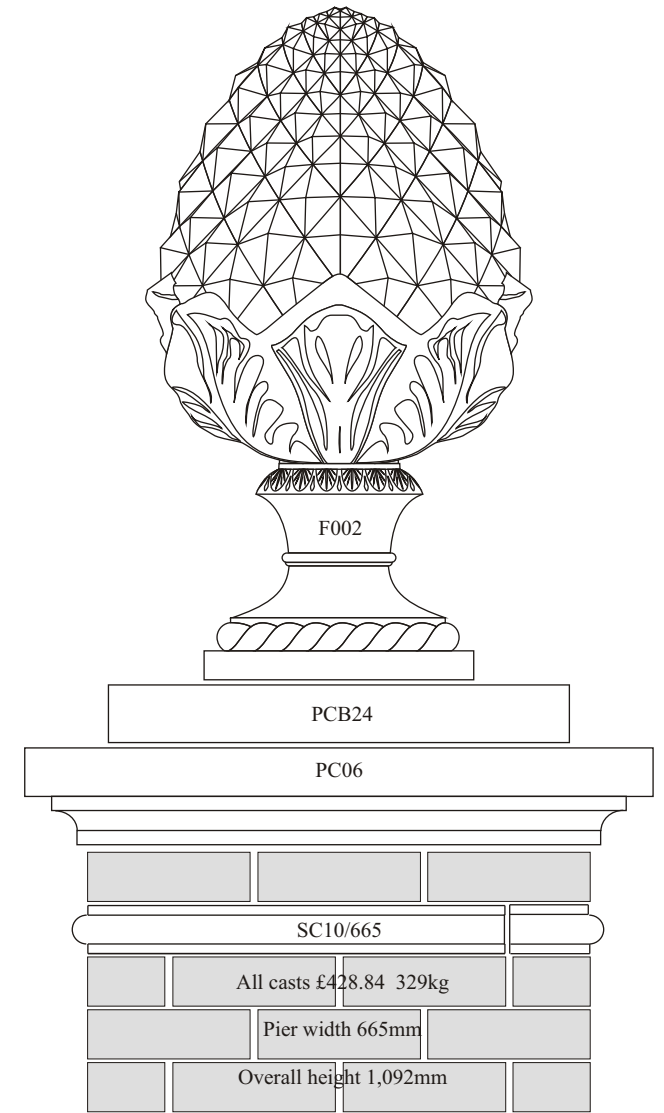
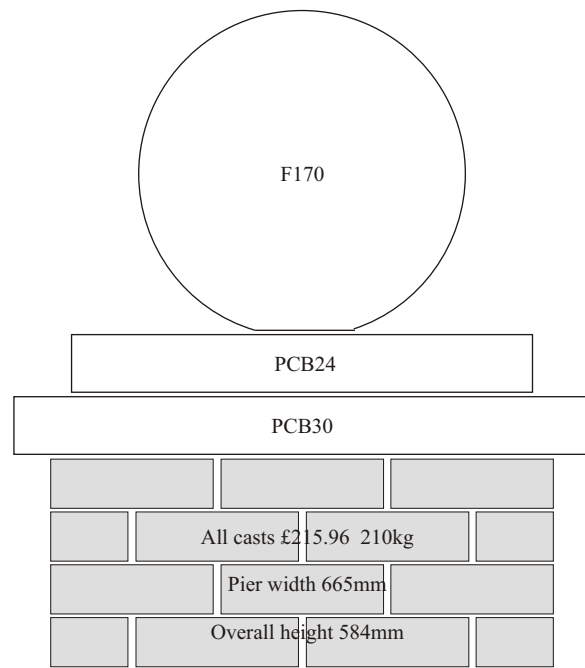
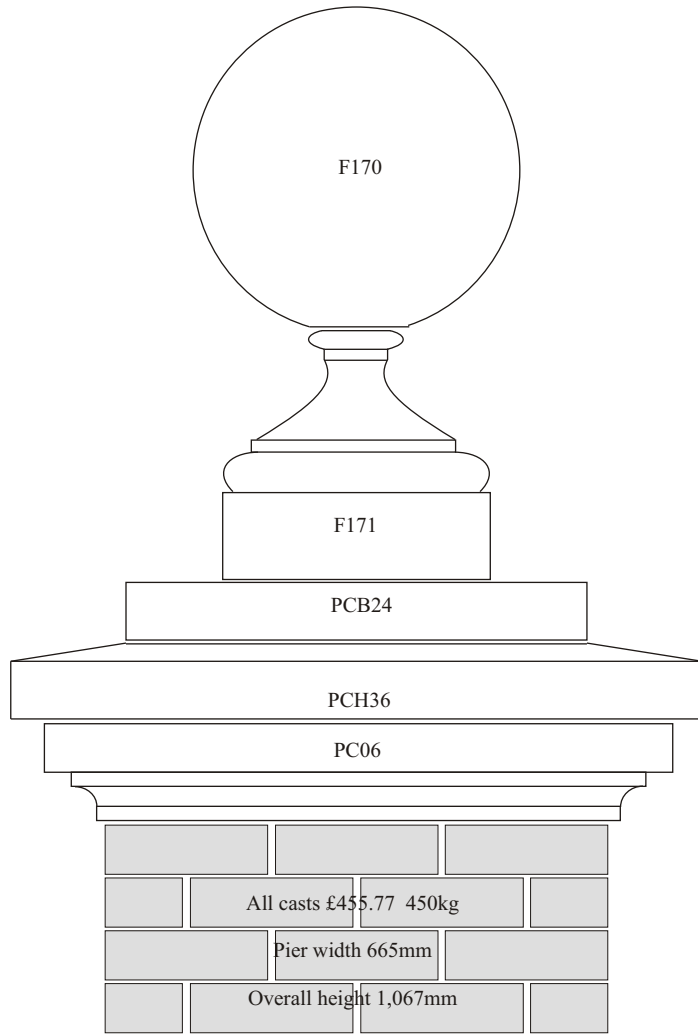

Prices valid until 01/01/10

Gate Piers

Scale 1:20

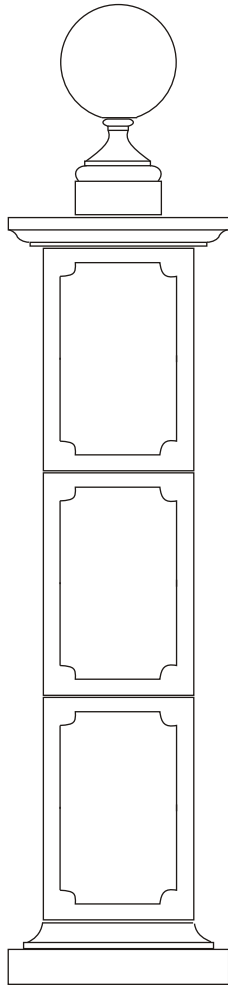

Gate Pier GP50
(Including Pier cap UP09C)
£409.49 360 Kg

Height 2,029 (including 24mm of grouting)
Extra 588mm of shaft (GP52): £88.00

Core: minimum 250mm square.

Illustrated with 12" ball F120 and Square base F121

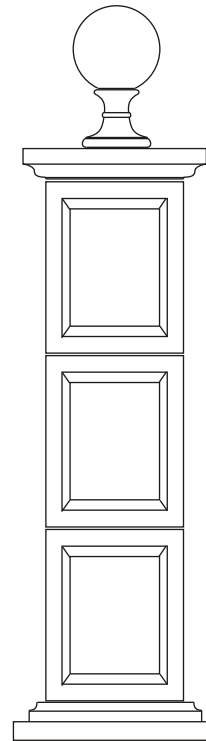

Gate Pier GP30
(Including Pier cap UP04C)
£287.96 201 Kg

Height 1,563 (including 24mm of grouting)
Extra 453mm of shaft (GP32): £55.00

Illustrated with 9" ball F090 and Round base F092

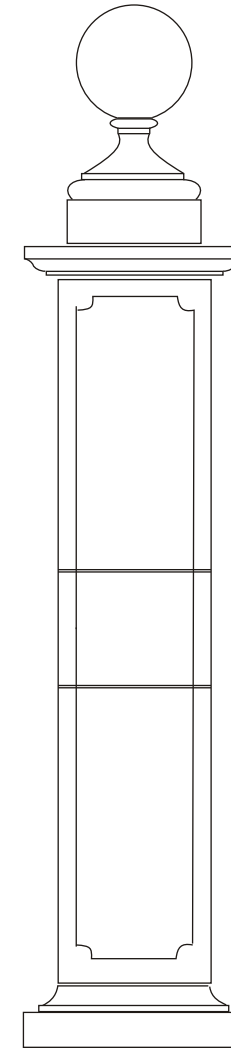

Gate Pier GP40
(Including Pier cap UP09C)
£399.81 305 Kg

Height 2,121 (including 30mm of grouting)
Extra 300mm of shaft (GP43): £57.20

Core: minimum 250mm square

Illustrated with 12" ball F120 and Square base F171

Finial details are on page 4.2. See Appendix for full details.

Prices valid until 01/01/10

Gate Piers

Scale 1:20

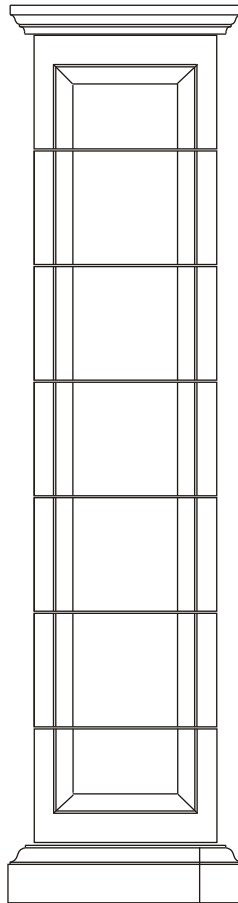

Gate Pier GP10
Including Pier cap (PCD24)
Height 2,340 (including 12mm of grouting)
£660.95 597kg
Extra 300mm of shaft (GP13): £72.60
Core: minimum 320mm square.

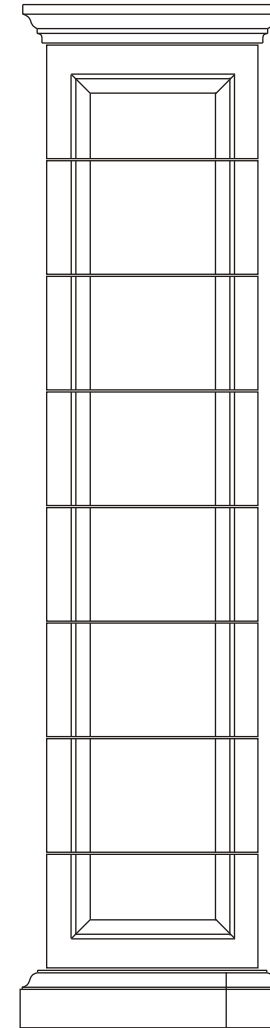

Gate Pier GP20
Including Pier cap (PCD27)
Height 2,666 (including 12mm of grouting)
£860.40 900kg
Extra 300mm of shaft (GP23): £84.70
Core: minimum 359mm square.

Prices valid until 01/01/10

Gate Piers

Scale 1:20

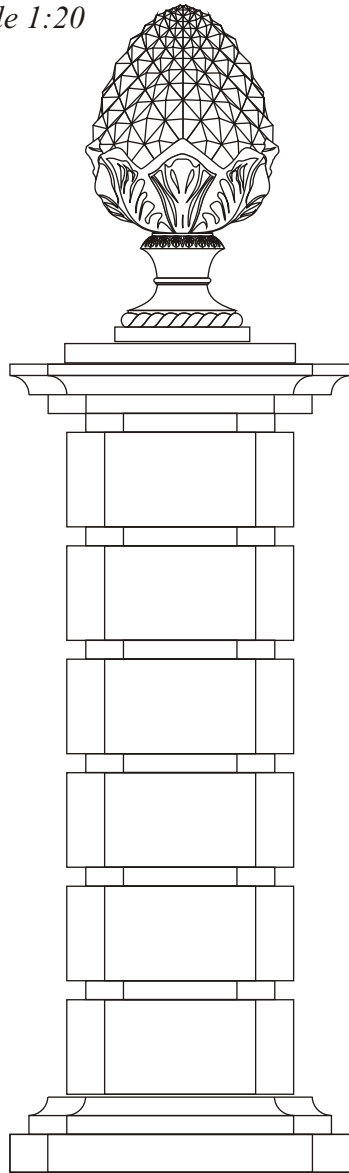

Left

Gate Pier GP70
Including pier cap (GP73)
Height 2,130mm
£1,089.00 773kg
Extra 300mm of shaft (GP72): £121.00
Core: minimum 200mm square
Illustrated with F002 and PCB24

Plan

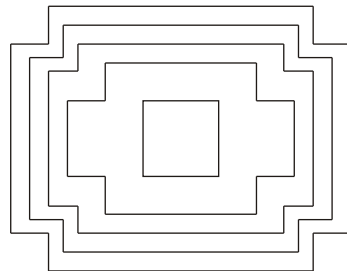

Right

Gate Pier GP80
Height 2,274mm (excluding lower shaft)
£1,089.00 652kg
Extra 300mm of shaft (GP82): £163.35
Core diameter approximately 500mm

Plan

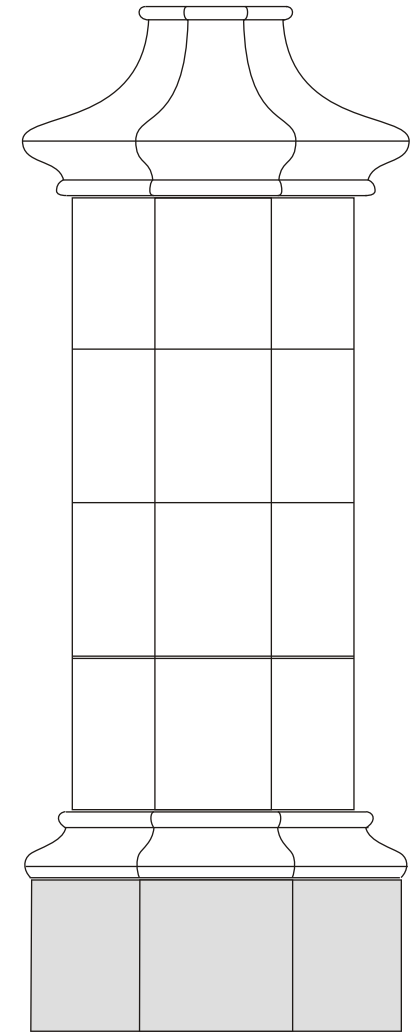
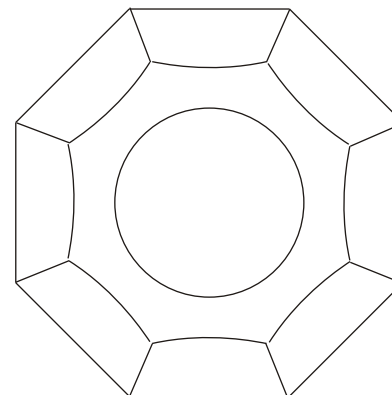

Prices valid until 01/01/10

Finial details are on page 4.2. See Appendix for full details.

Gate Piers

Scale 1:20

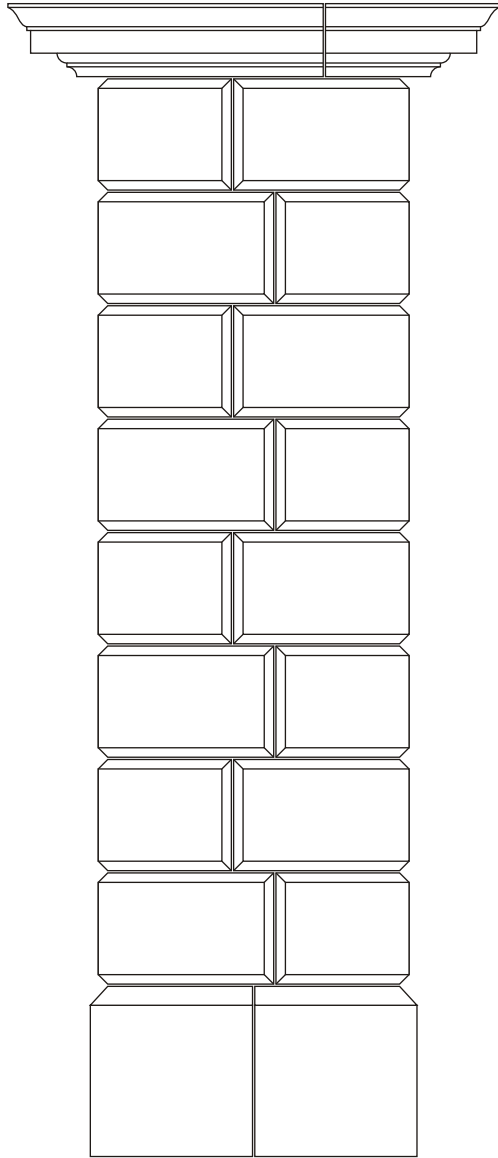

Left

Gate Pier GP60 Configuration A
Including pier cap (GP63)
Height 3,054mm (including 60mm of grouting)
£1,500.12 2,088kg
Extra 294mm of shaft (GP62): £119.76
Core: minimum 562mm square

Right

Gate Pier GP60 Configuration B
Including pier cap (GP63)
Height 3,054mm (including 60mm of grouting)
£1,887.32 2,362kg
Extra 294mm of shaft (GP62): £141.54
Core: minimum 675mm square

Note

A variety of gate piers can be
designed using standard components.
Please ask for details.

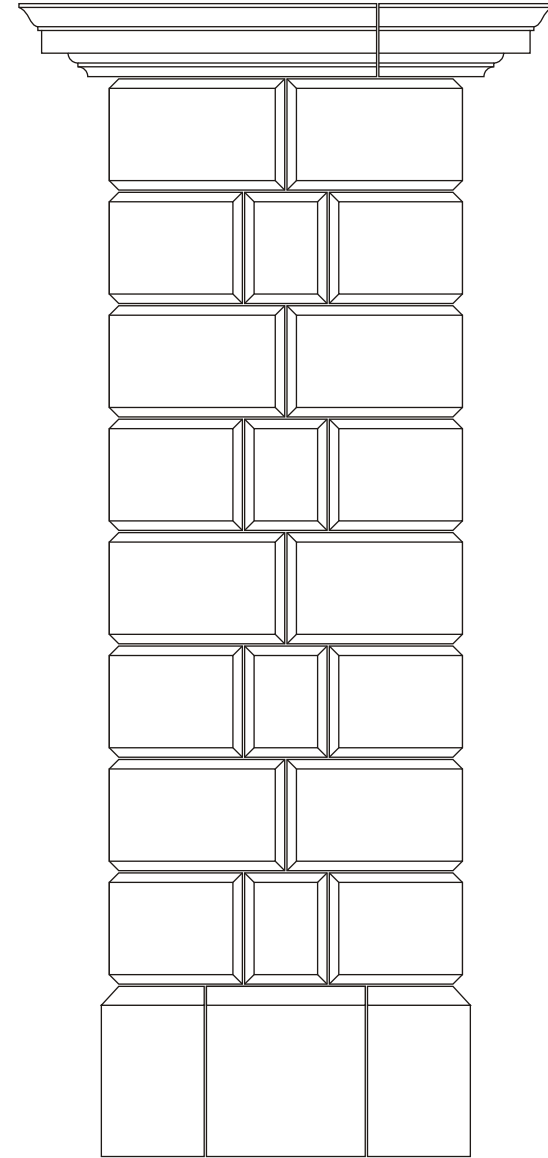

Prices valid until 01/01/10

Wall Coping: Plain and Part Weathered

Scale 1:10

Plain

Part weathered

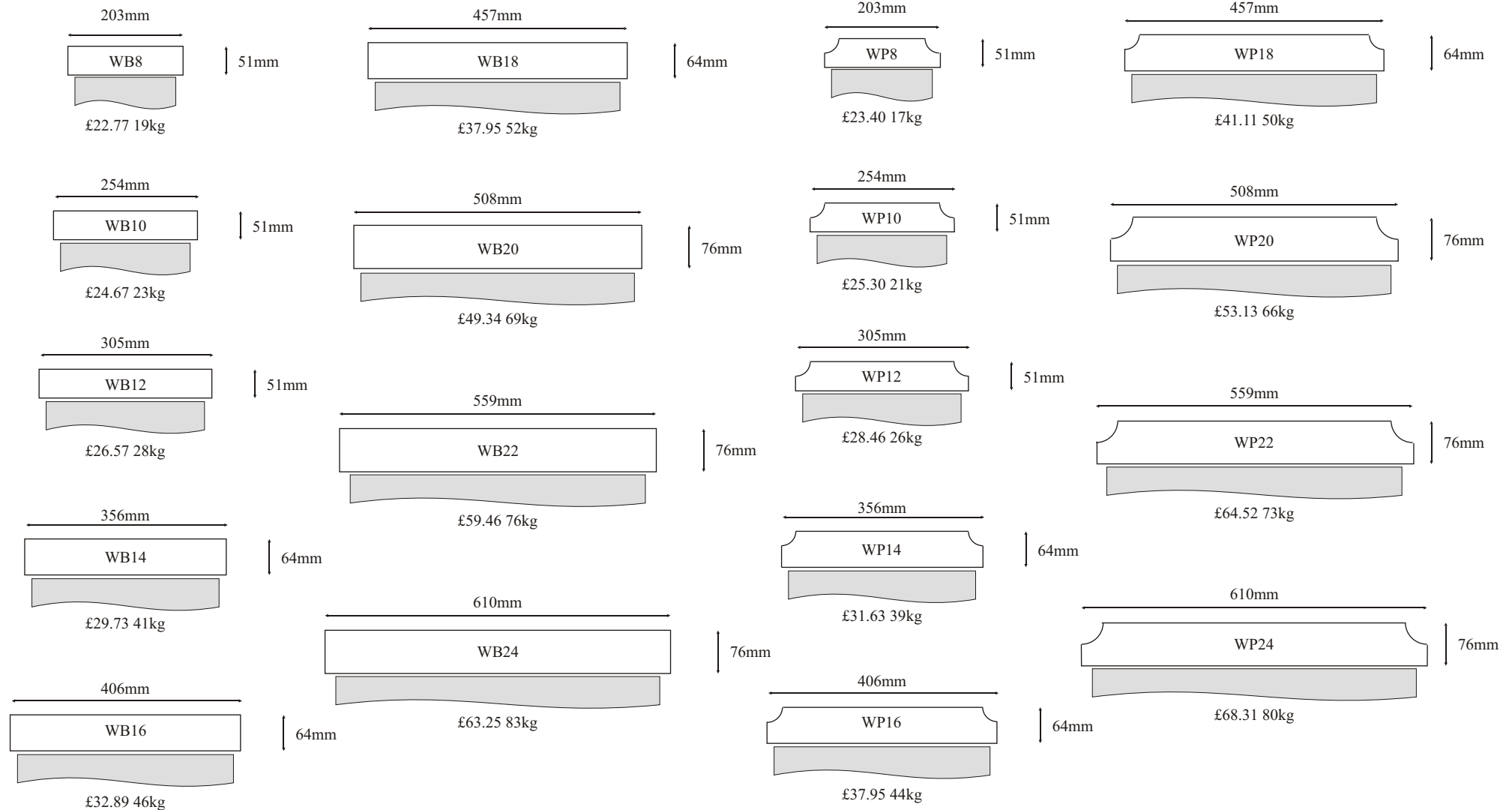

Allow 25-35mm (min) overhang, on each side, for drip channels Prices valid until 01/01/10

All copings are supplied throated. All copings are supplies in whole lengths of 1,000mm. Corner sections, curved and sloping sections are also available.

Wall Coping: Once Weathered and Twice Weathered

Once weathered
Scale 1:10

Twice weathered

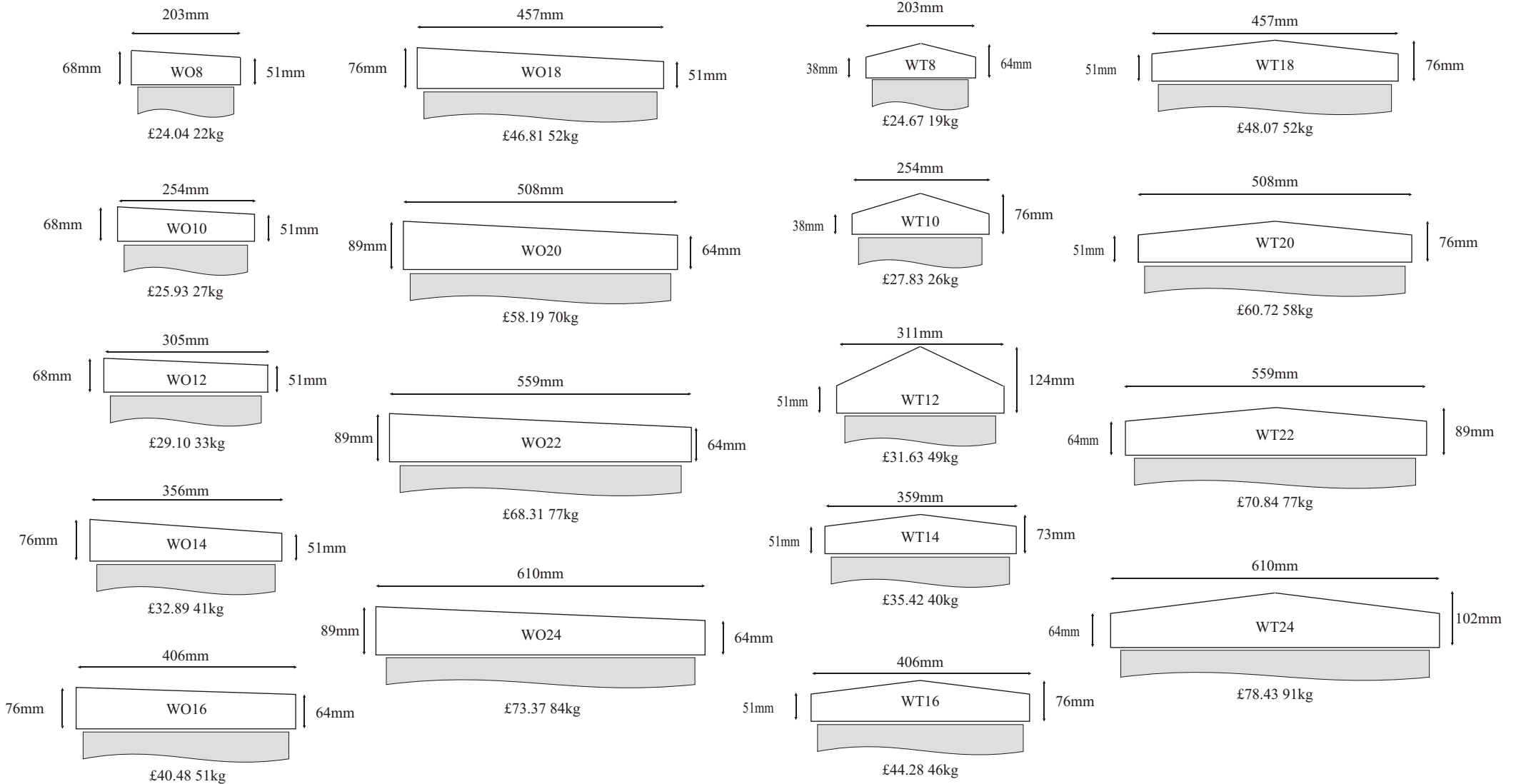

Allow 25-35mm (min) overhang, on each side, for drip channels Prices valid until 01/01/10

All copings are supplied throated. All copings are supplies in whole lengths of 1,000mm. Corner sections, curved and sloping sections are also available.

Wall Coping: Flat Decorated and Twice Weathered Decorated

Scale 1:10

Flat decorated

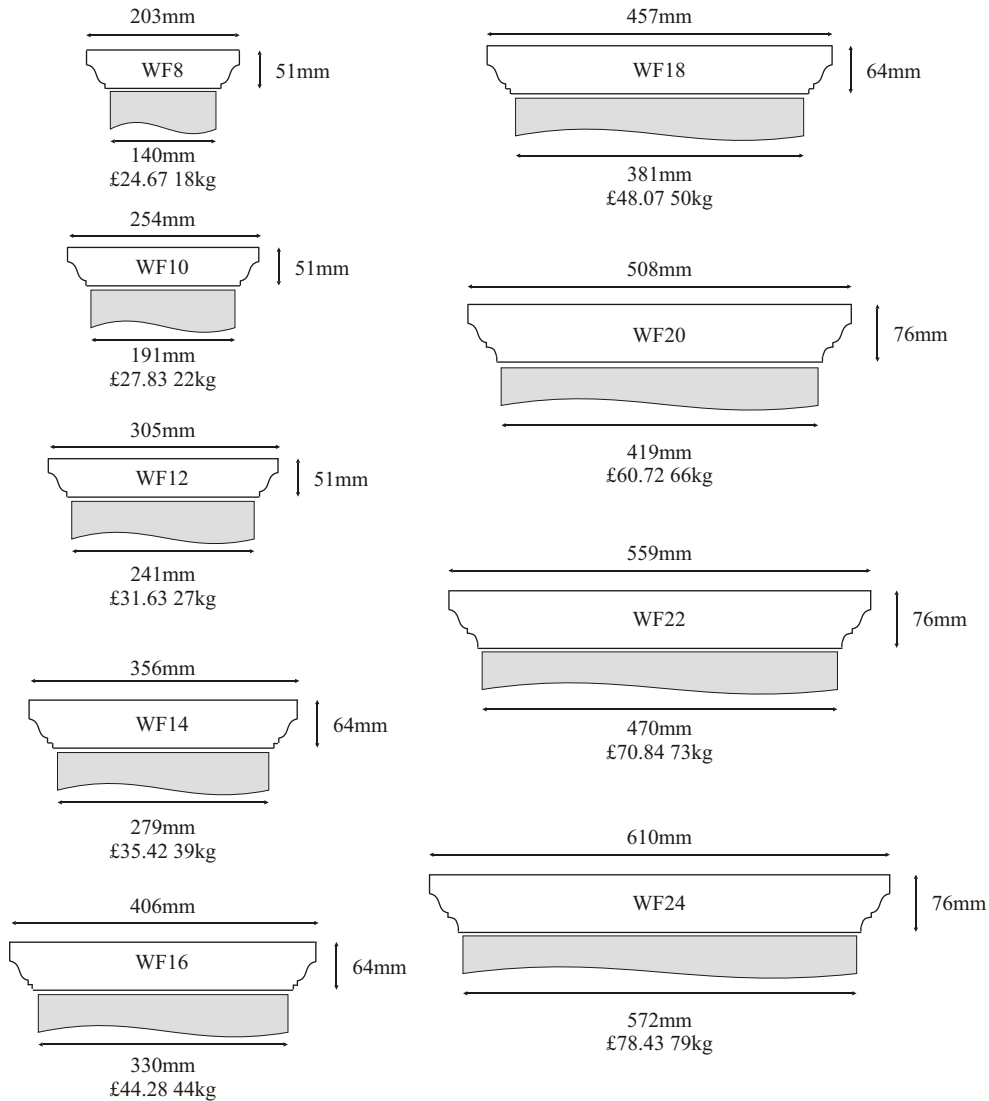

Twice weathered decorated

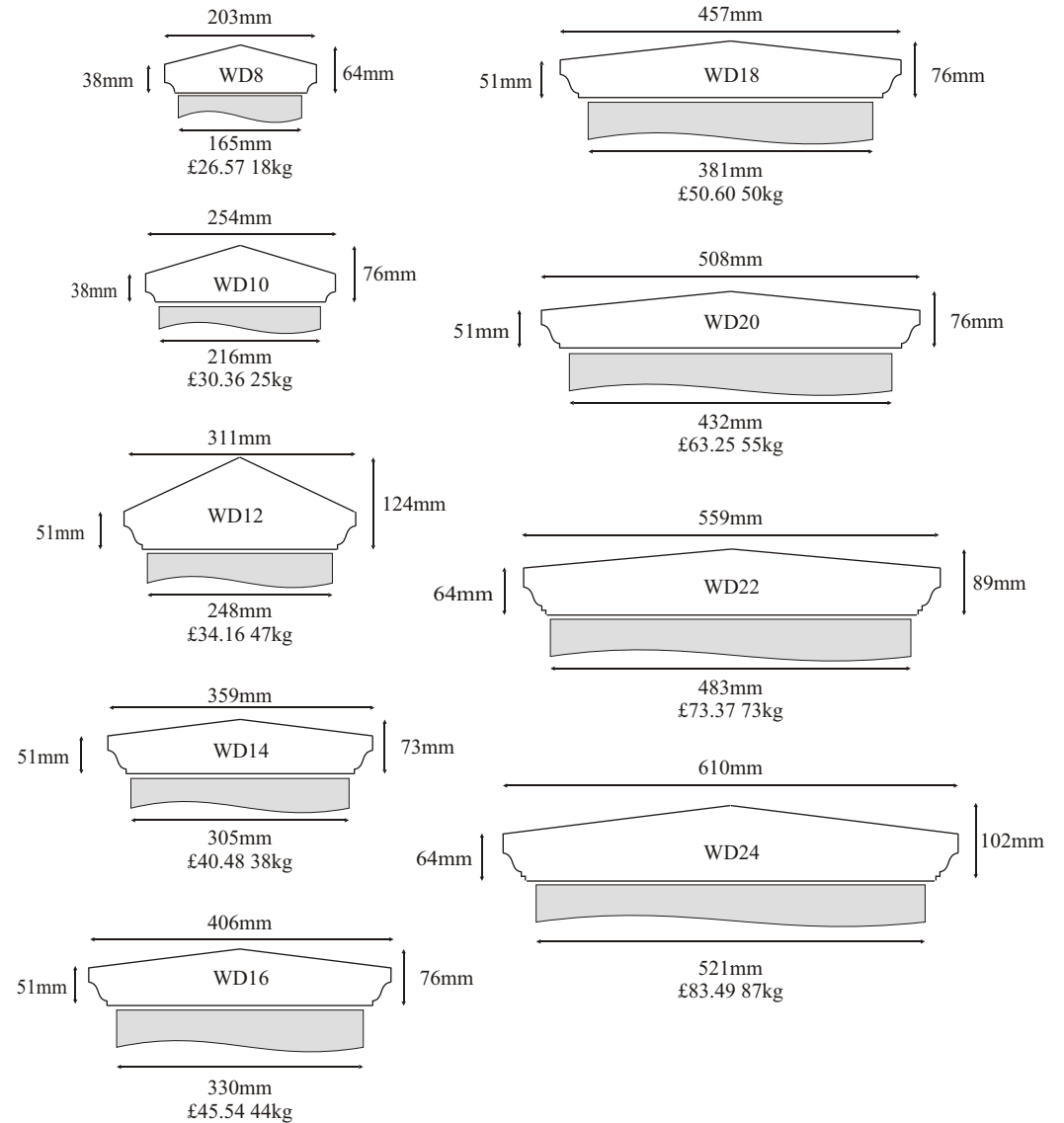

Allow 25-35mm (min) overhang, on each side, for drip channels Prices valid until 01/01/10

All copings are supplied throated. All copings are supplies in whole lengths of 1,000mm. Corner sections, curved and sloping sections are also available.

Miscellaneous Wall Coping

Scale 1:10

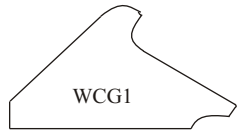

Wall coping WCG1
 £56.93 46kg
 Max. width 300mm, wall width 240mm
 Height 162mm *See also page 4.21*



Wall coping WCG2
 £32.89 26kg
 Max. width 190mm Height 108mm

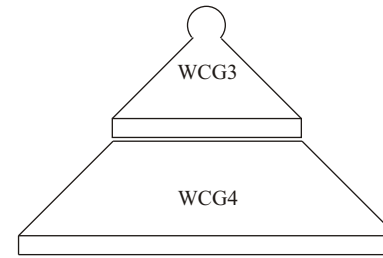

Wall coping WCG3
 £37.95 per 878mm cast 34kg
 Max. width 250mm, height 175mm

Under coping WCG4
 £78.43 per 878mm cast 88kg
 Max. width 500mm, height 150mm

Scale 1:20

Crenellated wall using WCG3 and WCG4

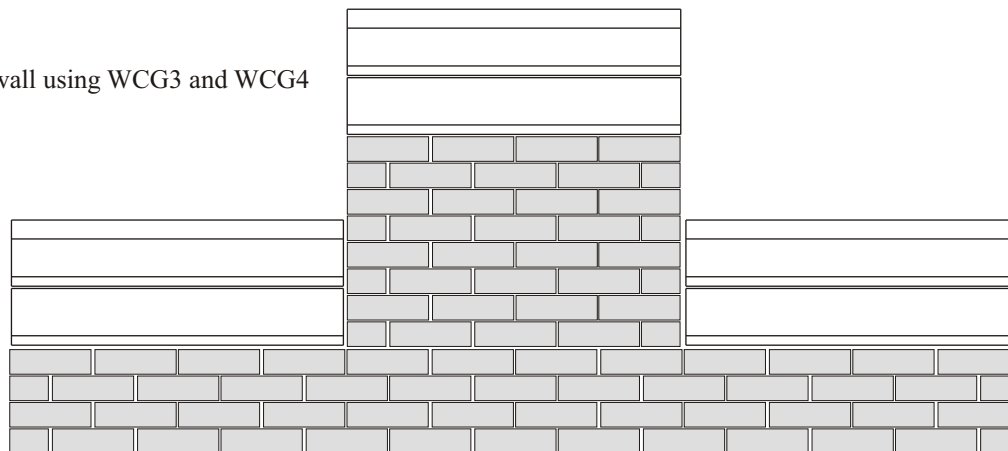

Prices valid until 01/01/10

Gothic Wall

Scale 1:20

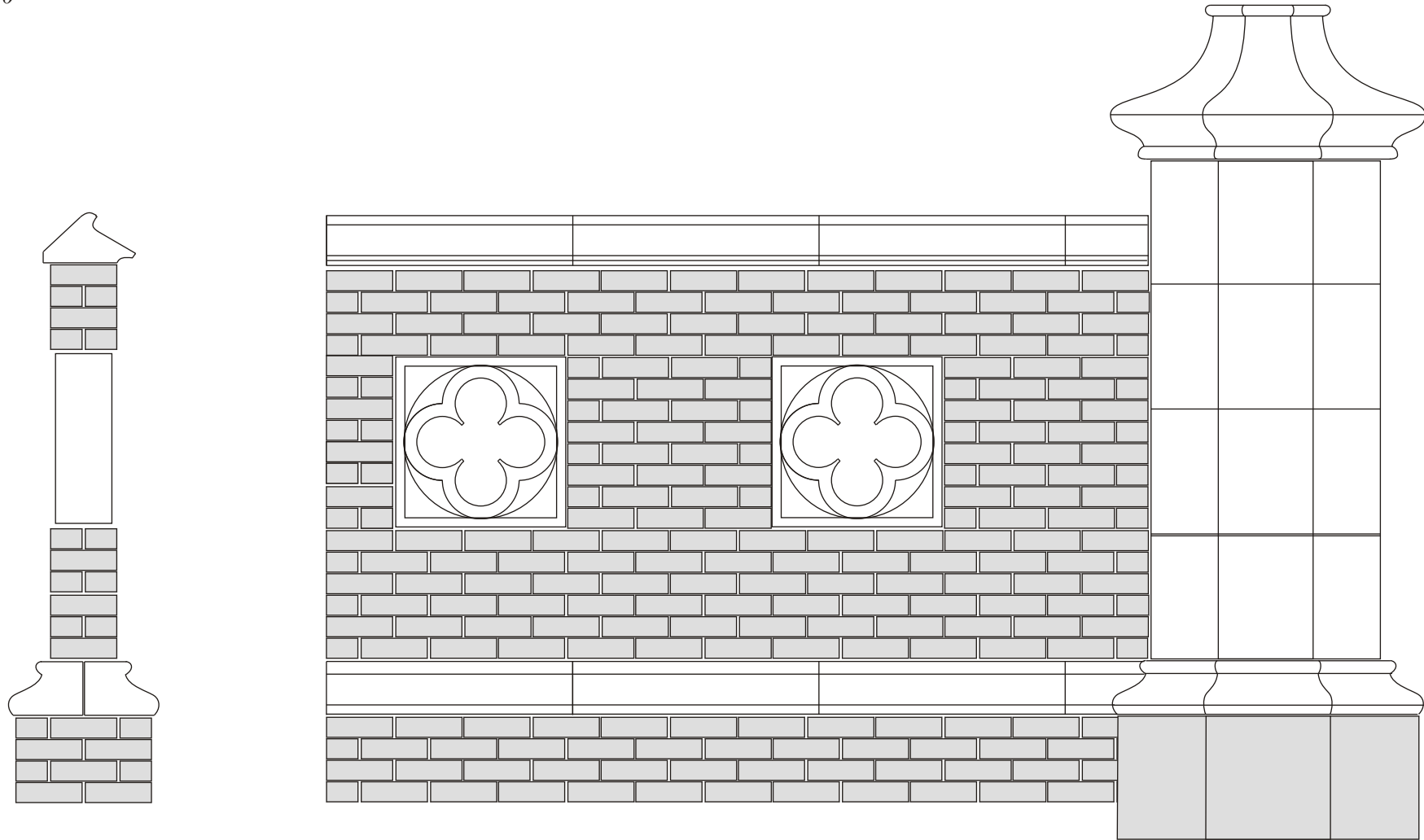

Gothic Wall.
Wall Coping WCG1, with Wall Plinth WP11 and Quatrefoils BS31
Approximately £197.80 per metre. Please call for a quotation
Illustrated with Gate Pier GP80 *See page 4.15*

Prices valid until 01/01/10

Appendix

| Code | Name | Price Excl. VAT | Weight (Kg) | Height (mm) | Width/ length 1 | Width/ length 2 | Comments |
|-----------------|-----------------------------|--------------------|----------------|----------------|--------------------|--------------------|-----------------|
| <i>Page 4.2</i> | | | | | | | |
| F090 | 9" Ball only | £35.57 | 12 | 229 | 229 | 229 | |
| UP06P | Renaissance Plinth - plinth | £25.53 | 18 | 122 | 303 | 303 | |
| F092 | Round Base only | £22.47 | 4 | 152 | 178 | 178 | |
| UP11 | Chamfered block | £25.53 | 25 | 165 | 330 | 330 | |
| F121 | Square Base (9") only | £21.53 | 16 | 254 | 229 | 229 | |
| F093 | Sloping Base only | £24.34 | 28 | 279 | 356 | 356 | |
| F171 | Square Base (14") only | £46.81 | 32 | 330 | 356 | 356 | |
| F120 | 12" Ball only | £52.85 | 30 | 301 | 305 | 305 | |
| <i>Page 4.3</i> | | | | | | | |
| F170 | 17" Ball only | £93.96 | 80 | 432 | 432 | 432 | |
| UP06P | Renaissance Plinth - plinth | £25.53 | 18 | 122 | 303 | 303 | |
| UP11 | Chamfered block | £25.53 | 25 | 165 | 330 | 330 | |
| F093 | Sloping Base only | £24.34 | 28 | 279 | 356 | 356 | |
| F171 | Square Base (14") only | £46.81 | 32 | 330 | 356 | 356 | |
| F002B | Rope pattern base | £51.06 | 24 | 277 | 356 | 356 | |
| F002 | Pineapple and base | £194.04 | 104 | 889 | 508 | 508 | 2 casts |
| <i>Page 4.4</i> | | | | | | | |
| F001 | Obelisk | £97.02 | 68 | 1,105 | 254 | 254 | |
| UP07 | Georgian Pedestal | £117.45 | 96 | 813 | 406 | 406 | 3 casts |
| UP04 | Panelled Pedestal | £122.55 | 119 | 635 | 480 | 480 | 3 casts |
| UP11 | Chamfered block | £25.53 | 25 | 165 | 330 | 330 | |
| UP08 | French Pedestal | £153.19 | 126 | 838 | 533 | 533 | 3 casts |
| UP09 | Victorian Pedestal | £178.72 | 160 | 848 | 584 | 584 | 3 casts |
| <i>Page 4.5</i> | | | | | | | |
| PCB10 | Pier cap - plain - 10" | £11.00 | 6 | 51 | 254 | 254 | |
| PCB12 | Pier cap - plain - 12" | £13.00 | 8 | 51 | 293 | 293 | Not illustrated |
| PCB14 | Pier cap - plain - 14" | £16.00 | 15 | 64 | 356 | 356 | |
| PCB16 | Pier cap - plain - 16" | £22.00 | 19 | 64 | 406 | 406 | Not illustrated |
| PCB18 | Pier cap - plain - 18" | £26.00 | 24 | 64 | 457 | 457 | Not illustrated |
| PCB20 | Pier cap - plain - 20" | £30.00 | 35 | 76 | 508 | 508 | |
| PCB22 | Pier cap - plain - 22" | £40.00 | 43 | 76 | 559 | 559 | Not illustrated |
| PCB24 | Pier cap - plain - 24" | £50.00 | 51 | 76 | 610 | 610 | |

Prices valid until 01/01/10

Appendix

| Code | Name | Price Excl. VAT | Weight (Kg) | Height (mm) | Width/ length 1 | Width/ length 2 | Comments |
|-------|---------------------------------|--------------------|----------------|----------------|--------------------|--------------------|-----------------|
| PCB30 | Pier cap - plain - 30" | £72.00 | 79 | 76 | 762 | 762 | |
| PCB36 | Pier cap - plain - 36" | £120.00 | 134 | 89 | 914 | 914 | |
| PCB40 | Pier cap - plain - 40" | £150.00 | 165 | 89 | 1,016 | 1,016 | Not illustrated |
| PCP10 | Pier cap - part weathered - 10" | £12.00 | 6 | 51 | 254 | 254 | |
| PCP14 | Pier cap - part weathered - 14" | £16.00 | 14 | 64 | 356 | 356 | |
| PCP20 | Pier cap - part weathered - 20" | £36.00 | 34 | 76 | 508 | 508 | |
| PCP24 | Pier cap - part weathered - 24" | £60.00 | 48 | 76 | 610 | 610 | |
| PCP30 | Pier cap - part weathered - 30" | £80.00 | 75 | 76 | 762 | 762 | |
| PCP36 | Pier cap - part weathered - 36" | £125.00 | 127 | 89 | 914 | 914 | |
| PCP40 | Pier cap - part weathered - 40" | £160.00 | 157 | 89 | 1,016 | 1,016 | Not illustrated |

Page 4.6

| | | | | | | | |
|-------|---------------------------------|---------|-----|-----|-----|-----|--|
| UP06C | Renaissance Plinth - cap | £25.53 | 10 | 67 | 303 | 303 | |
| UP05C | Classical Plinth - cap | £25.53 | 13 | 66 | 330 | 330 | |
| UP07C | Georgian Plinth - cap | £31.66 | 16 | 127 | 406 | 406 | |
| PCD16 | Pier cap - flat decorated - 16" | £30.00 | 18 | 64 | 406 | 406 | |
| PCD18 | Pier cap - flat decorated - 18" | £33.00 | 23 | 64 | 457 | 457 | |
| PCD20 | Pier cap - flat decorated - 20" | £40.00 | 34 | 76 | 508 | 508 | |
| PCD21 | Pier cap - flat decorated - 21" | £46.00 | 36 | 80 | 533 | 533 | |
| PCD22 | Pier cap - flat decorated - 22" | £52.00 | 41 | 76 | 559 | 559 | |
| PCD23 | Pier cap - flat decorated - 23" | £60.00 | 45 | 78 | 584 | 584 | |
| PCD24 | Pier cap - flat decorated - 24" | £62.00 | 48 | 76 | 610 | 610 | |
| PCD27 | Pier cap - flat decorated - 27" | £86.00 | 82 | 102 | 686 | 686 | |
| PCD30 | Pier cap - flat decorated - 30" | £106.00 | 101 | 102 | 762 | 762 | |
| PC06 | Pier cap - flat decorated - 32" | £125.00 | 147 | 127 | 823 | 823 | |
| PC07 | Pier cap - flat decorated - 36" | £170.00 | 172 | 127 | 914 | 914 | |

Page 4.7

| | | | | | | | |
|-------|----------------------------|--------|----|-----|-----|-----|--|
| PCT8 | Pier cap - weathered - 8" | £11.00 | 3 | 64 | 203 | 203 | |
| PCT10 | Pier cap - weathered - 10" | £14.00 | 6 | 76 | 254 | 254 | |
| PCT12 | Pier cap - weathered - 12" | £18.00 | 11 | 102 | 311 | 311 | |
| PCT14 | Pier cap - weathered - 14" | £22.00 | 15 | 102 | 359 | 359 | |

Prices valid until 01/01/10

Appendix

| Code | Name | Price Excl. VAT | Weight (Kg) | Height (mm) | Width/ length 1 | Width/ length 2 | Comments |
|-------|----------------------------|--------------------|----------------|----------------|--------------------|--------------------|-----------------|
| PCT16 | Pier cap - weathered - 16" | £28.00 | 24 | 127 | 406 | 406 | |
| PCT18 | Pier cap - weathered - 18" | £36.00 | 30 | 127 | 457 | 457 | |
| PCT20 | Pier cap - weathered - 20" | £44.00 | 37 | 127 | 508 | 508 | |
| PCT22 | Pier cap - weathered - 22" | £60.00 | 53 | 152 | 559 | 559 | |
| PCT24 | Pier cap - weathered - 24" | £65.00 | 64 | 152 | 610 | 610 | |
| PCT27 | Pier cap - weathered - 27" | £85.00 | 70 | 152 | 686 | 686 | |
| PCT30 | Pier cap - weathered - 30" | £115.00 | 95 | 178 | 762 | 762 | |
| PCT35 | Pier cap - weathered - 35" | £145.00 | 110 | 191 | 881 | 881 | |
| PCT36 | Pier cap - weathered - 36" | £165.00 | 120 | 204 | 915 | 915 | |
| PCT37 | Pier cap - weathered - 37" | £165.00 | 120 | 162 | 940 | 940 | Not illustrated |

Page 4.8

| | | | | | | | |
|--------|--------------------------------------|---------|-----|-----|-----|-----|--|
| PCWD12 | Pier cap - weathered decorated - 12" | £33.00 | 12 | 102 | 311 | 311 | |
| PCT14 | Pier cap - weathered - 14" | £22.00 | 15 | 102 | 359 | 359 | |
| UP05C | Classical Plinth - cap | £25.53 | 13 | 66 | 330 | 330 | |
| PCWD16 | Pier cap - weathered decorated - 16" | £41.80 | 21 | 102 | 406 | 406 | |
| PCT16 | Pier cap - weathered - 16" | £28.00 | 24 | 127 | 406 | 406 | |
| UP05C | Classical Plinth - cap | £25.53 | 13 | 66 | 330 | 330 | |
| PCT18 | Pier cap - weathered - 18" | £36.00 | 30 | 127 | 457 | 457 | |
| PCD16 | Pier cap - flat decorated - 16" | £30.00 | 18 | 64 | 406 | 406 | |
| PCT24 | Pier cap - weathered - 24" | £65.00 | 64 | 152 | 610 | 610 | |
| PCD22 | Pier cap - flat decorated - 22" | £52.00 | 41 | 76 | 559 | 559 | |
| PCT30 | Pier cap - weathered - 30" | £115.00 | 95 | 178 | 762 | 762 | |
| PCD27 | Pier cap - flat decorated - 27" | £86.00 | 82 | 102 | 686 | 686 | |
| PCT35 | Pier cap - weathered - 35" | £145.00 | 110 | 191 | 881 | 881 | |
| PCD30 | Pier cap - flat decorated - 30" | £106.00 | 101 | 102 | 762 | 762 | |
| PCT36 | Pier cap - weathered - 36" | £165.00 | 120 | 204 | 915 | 915 | |
| PC06 | Pier cap - flat decorated - 32" | £125.00 | 147 | 127 | 823 | 823 | |
| PCWD24 | Pier cap - weathered decorated - 24" | £66.00 | 85 | 165 | 610 | 610 | |

Page 4.9

| | | | | | | | |
|-------|---------------------------------|--------|----|-----|-----|-----|--|
| PCB10 | Pier cap - plain - 10" | £11.00 | 6 | 51 | 254 | 254 | |
| PCH18 | Pier cap - half weathered - 18" | £44.00 | 34 | 101 | 457 | 457 | |

Prices valid until 01/01/10

Appendix

| Code | Name | Price Excl. VAT | Weight (Kg) | Height (mm) | Width/ length 1 | Width/ length 2 | Comments |
|-------|---------------------------------|--------------------|----------------|----------------|--------------------|--------------------|----------|
| PCD16 | Pier cap - flat decorated - 16" | £30.00 | 18 | 64 | 406 | 406 | |
| PCB14 | Pier cap - plain - 14" | £16.00 | 15 | 64 | 356 | 356 | |
| PCH24 | Pier cap - half weathered - 24" | £70.00 | 62 | 102 | 610 | 610 | |
| PCD22 | Pier cap - flat decorated - 22" | £52.00 | 41 | 76 | 559 | 559 | |
| PCB18 | Pier cap - plain - 18" | £26.00 | 24 | 64 | 457 | 457 | |
| PCH30 | Pier cap - half weathered - 30" | £110.00 | 97 | 102 | 762 | 762 | |
| PCD27 | Pier cap - flat decorated - 27" | £86.00 | 82 | 102 | 686 | 686 | |
| PCB24 | Pier cap - plain - 24" | £50.00 | 51 | 76 | 610 | 610 | |
| PCH36 | Pier cap - half weathered - 36" | £140.00 | 140 | 102 | 915 | 915 | |
| PC06 | Pier cap - flat decorated - 32" | £125.00 | 147 | 127 | 823 | 823 | |

Page 4.10

| | | | | | | | |
|-------|---------------------------------|--------|----|-----|-----|-----|--|
| F170 | 17" Ball only | £93.96 | 80 | 432 | 432 | 432 | |
| PCD22 | Pier cap - flat decorated - 22" | £52.00 | 41 | 76 | 559 | 559 | |
| PCB16 | Pier cap - plain - 16" | £22.00 | 19 | 64 | 406 | 406 | |
| F090 | 9" Ball only | £35.57 | 12 | 229 | 229 | 229 | |
| PCB20 | Pier cap - plain - 20" | £30.00 | 35 | 76 | 508 | 508 | |
| F092 | Round Base only | £22.47 | 4 | 152 | 178 | 178 | |
| F120 | 12" Ball only | £52.85 | 30 | 301 | 305 | 305 | |
| F121 | Square Base (9") only | £21.53 | 16 | 254 | 229 | 229 | |
| PCB16 | Pier cap - plain - 16" | £22.00 | 19 | 64 | 406 | 406 | |
| PCD22 | Pier cap - flat decorated - 22" | £52.00 | 41 | 76 | 559 | 559 | |

Page 4.11

| | | | | | | | |
|-------|------------------------|--------|----|-----|-----|-----|--|
| F170 | 17" Ball only | £93.96 | 80 | 432 | 432 | 432 | |
| F171 | Square Base (14") Only | £46.81 | 32 | 330 | 356 | 356 | |
| PCB20 | Pier Cap - Plain - 20" | £30.00 | 35 | 76 | 508 | 508 | |
| PCB24 | Pier Cap - Plain - 24" | £50.00 | 51 | 76 | 610 | 610 | |

Prices valid until 01/01/10

Appendix

| Code | Name | Price Excl. VAT | Weight (Kg) | Height (mm) | Width/ length 1 | Width/ length 2 | Comments |
|------------------|---------------------------------|--------------------|----------------|----------------|--------------------|--------------------|----------|
| F120 | 12" Ball Only | £52.85 | 30 | 301 | 305 | 305 | |
| F121 | Square Base (9") Only | £21.53 | 16 | 254 | 229 | 229 | |
| PCB16 | Pier Cap - Plain - 16" | £22.00 | 19 | 64 | 406 | 406 | |
| PCB22 | Pier Cap - Plain - 22" | £40.00 | 43 | 76 | 559 | 559 | |
| PCD27 | Pier Cap - Flat Decorated - 27" | £86.00 | 82 | 102 | 686 | 686 | |
| SC10/552 | Pier String Course - 552mm | £48.30 | 22 | 65 | 552 | 552 | |
| | | | | | | | |
| F090 | 9" Ball Only | £35.57 | 12 | 229 | 229 | 229 | |
| F093 | Sloping Base Only | £24.34 | 28 | 279 | 356 | 356 | |
| PCP24 | Pier Cap - Part Weathered - 24" | £60.00 | 48 | 76 | 610 | 610 | |
| SC10/552 | Pier String Course - 552mm | £48.30 | 22 | 65 | 552 | 552 | |
| | | | | | | | |
| <i>Page 4.12</i> | | | | | | | |
| F170 | 17" Ball Only | £93.96 | 80 | 432 | 432 | 432 | |
| F171 | Square Base (14") Only | £46.81 | 32 | 330 | 356 | 356 | |
| PCB24 | Pier Cap - Plain - 24" | £50.00 | 51 | 76 | 610 | 610 | |
| PCH36 | Pier Cap - Half Weathered - 36" | £140.00 | 140 | 102 | 915 | 915 | |
| PC06 | Pier Cap - Flat Decorated - 32" | £125.00 | 147 | 127 | 823 | 823 | |
| | | | | | | | |
| F170 | 17" Ball Only | £93.96 | 80 | 432 | 432 | 432 | |
| PCB24 | Pier Cap - Plain - 24" | £50.00 | 51 | 76 | 610 | 610 | |
| PCB30 | Pier Cap - Plain - 30" | £72.00 | 79 | 76 | 762 | 762 | |
| | | | | | | | |
| F002 | Pineapple and Base | £194.04 | 104 | 889 | 508 | 508 | |
| PCB24 | Pier Cap - Plain - 24" | £50.00 | 51 | 76 | 610 | 610 | |
| PC06 | Pier Cap - Flat Decorated - 32" | £125.00 | 147 | 127 | 823 | 823 | |
| SC10/665 | Pier String Course - 665mm | £59.80 | 27 | 65 | 665 | 665 | |

Page 4.13

| | | | | | | | |
|------|---|---------|-----|-------|-----|-----|--|
| GP50 | Gate Pier as illustrated (inc. cap UP09C) | £409.49 | 360 | 2,029 | 584 | 584 | |
|------|---|---------|-----|-------|-----|-----|--|

Prices valid until 01/01/10

Appendix

| Code | Name | Price Excl. VAT | Weight (Kg) | Height (mm) | Width/ length 1 | Width/ length 2 | Comments |
|-------|---|--------------------|----------------|----------------|--------------------|--------------------|----------|
| GP51 | Gate Pier - Plinth | £62.92 | 52 | 163 | 584 | 584 | |
| GP52 | Gate Pier - Shaft | £96.80 | 90 | 588 | 398 | 398 | |
| UP09C | Victorian Pedestal - Cap | £56.17 | 38 | 78 | 584 | 584 | |
| GP30 | Gate Pier as illustrated (inc. cap UP04C) | £287.96 | 186 | 1,563 | 536 | 536 | |
| GP31 | Gate Pier - Plinth | £60.50 | 30 | 100 | 536 | 536 | |
| GP32 | Gate Pier - Shaft | £60.50 | 45 | 453 | 364 | 364 | |
| UP04C | Panelled Pedestal - Cap | £45.96 | 36 | 88 | 480 | 480 | |
| GP40 | Gate Pier as illustrated (inc.cap UP09C) | £399.81 | 305 | 2,121 | 584 | 584 | |
| GP41 | Gate Pier - Plinth | £62.92 | 52 | 163 | 584 | 584 | |
| GP42 | Gate Pier - Shaft Top/Bottom | £108.90 | 90 | 775 | 405 | 405 | |
| GP43 | Gate Pier - Shaft | £62.92 | 35 | 300 | 405 | 405 | |
| UP09C | Victorian Pedestal - Cap | £56.17 | 38 | 78 | 584 | 584 | |

Page 4.14

| | | | | | | | |
|-------|---|---------|-----|-------|-----|-----|--|
| GP10 | Gate Pier as illustrated (inc. cap PCD24) | £660.95 | 590 | 2,328 | 623 | 623 | |
| GP11 | Gate Pier - Plinth (4 Casts) | £90.75 | 59 | 152 | 623 | 623 | |
| GP12 | Gate Pier - Shaft Base | £72.60 | 70 | 300 | 483 | 483 | |
| GP13 | Gate Pier - Shaft | £72.60 | 70 | 300 | 483 | 483 | |
| GP14 | Gate Pier - Shaft Top | £72.60 | 70 | 300 | 483 | 483 | |
| PCD24 | Pier Cap - Flat Decorated - 24" | £62.00 | 48 | 76 | 610 | 610 | |
| GP20 | Gate Pier as illustrated (inc.cap PCD27) | £860.40 | 900 | 2,654 | 699 | 699 | |
| GP21 | Gate Pier - Plinth (4 Casts) | £96.80 | 66 | 152 | 699 | 699 | |
| GP22 | Gate Pier - Shaft Base | £84.70 | 94 | 300 | 559 | 559 | |
| GP23 | Gate Pier - Shaft | £84.70 | 94 | 300 | 559 | 559 | |
| GP24 | Gate Pier - Shaft Top | £84.70 | 94 | 300 | 559 | 559 | |
| PCD27 | Pier Cap - Flat Decorated - 27" | £86.00 | 82 | 102 | 686 | 686 | |

Page 4.15

| | | | | | | | |
|------|--|-----------|-----|-------|-----|-----|--|
| GP70 | Gate Pier as illustrated (inc. pier cap) | £1,089.00 | 773 | 2,130 | 900 | 700 | |
|------|--|-----------|-----|-------|-----|-----|--|

Prices valid until 01/01/10

Appendix

| Code | Name | Price Excl. VAT | Weight (Kg) | Height (mm) | Width/ length 1 | Width/ length 2 | Comments |
|------------------|--|--------------------|----------------|----------------|--------------------|--------------------|----------|
| GP71 | Gate Pier - Plinth | £242.00 | 150 | 200 | 900 | 700 | |
| GP72 | Gate Pier - Shaft | £121.00 | 86 | 300 | 600 | 400 | |
| GP73 | Gate Pier - Cap | £121.00 | 107 | 130 | 900 | 700 | |
| GP80 | Gate Pier as illustrated (excl. lower shaft) | £1,089.00 | 652 | 2,274 | 1,024 | 1,024 | |
| GP81 | Gate Pier Cap | £217.80 | 110 | 500 | 1,024 | 1,024 | |
| GP82 | Gate Pier Shaft | £163.35 | 117 | 400 | 745 | 745 | |
| GP83 | Gate Pier Plinth | £217.80 | 74 | 174 | 1,024 | 1,024 | |
| <i>Page 4.16</i> | | | | | | | |
| GP61 | Gate Pier - Plinth Corner | £53.24 | 82 | 450 | 431 | 431 | |
| GP62 | Gate Pier - Quoin | £29.94 | 45 | 294 | 464 | 352 | |
| GP63 | Pier Cap Cornice - Per Section | £82.28 | 80 | 192 | 802 | 522 | |
| GP64 | Gate Pier - Champhered Block | £10.89 | 14 | 294 | 218 | 127 | |
| GP65 | Gate Pier - Plinth Straight | £53.24 | 50 | 450 | 420 | 102 | |
| <i>Page 4.17</i> | | | | | | | |
| WB8 | Wall Coping - Plain - 8" | £22.77 | 19 | 51 | 203 | 1,000 | |
| WB10 | Wall Coping - Plain - 10" | £24.67 | 23 | 51 | 254 | 1,000 | |
| WB12 | Wall Coping - Plain - 12" | £26.57 | 28 | 51 | 305 | 1,000 | |
| WB14 | Wall Coping - Plain - 14" | £29.73 | 41 | 64 | 356 | 1,000 | |
| WB16 | Wall Coping - Plain - 16" | £32.89 | 46 | 64 | 406 | 1,000 | |
| WB18 | Wall Coping - Plain - 18" | £37.95 | 52 | 64 | 457 | 1,000 | |
| WB20 | Wall Coping - Plain - 20" | £49.34 | 69 | 76 | 508 | 1,000 | |
| WB22 | Wall Coping - Plain - 22" | £59.46 | 76 | 76 | 559 | 1,000 | |
| WB24 | Wall Coping - Plain - 24" | £63.25 | 83 | 76 | 610 | 1,000 | |
| WP8 | Wall Coping - Part Weathered - 8" | £23.40 | 16 | 51 | 203 | 1,000 | |
| WP10 | Wall Coping - Part Weathered - 10" | £25.30 | 21 | 51 | 254 | 1,000 | |
| WP12 | Wall Coping - Part Weathered - 12" | £28.46 | 26 | 51 | 305 | 1,000 | |
| WP14 | Wall Coping - Part Weathered - 14" | £31.63 | 39 | 64 | 356 | 1,000 | |

Prices valid until 01/01/10

Appendix

| Code | Name | Price Excl. VAT | Weight (Kg) | Height (mm) | Width/ length 1 | Width/ length 2 | Comments |
|------|------------------------------------|--------------------|----------------|----------------|--------------------|--------------------|----------|
| WP16 | Wall Coping - Part Weathered - 16" | £37.95 | 44 | 64 | 406 | 1,000 | |
| WP18 | Wall Coping - Part Weathered - 18" | £41.11 | 50 | 64 | 457 | 1,000 | |
| WP20 | Wall Coping - Part Weathered - 20" | £53.13 | 66 | 76 | 508 | 1,000 | |
| WP22 | Wall Coping - Part Weathered - 22" | £64.52 | 73 | 76 | 559 | 1,000 | |
| WP24 | Wall Coping - Part Weathered - 24" | £68.31 | 80 | 76 | 610 | 1,000 | |

Page 4.18

| | | | | | | | |
|------|------------------------------------|--------|----|----|-----|-------|--|
| WO8 | Wall Coping - Once Weathered - 8" | £24.04 | 22 | 68 | 203 | 1,000 | |
| WO10 | Wall Coping - Once Weathered - 10" | £25.93 | 27 | 68 | 254 | 1,000 | |
| WO12 | Wall Coping - Once Weathered - 12" | £29.10 | 33 | 68 | 305 | 1,000 | |
| WO14 | Wall Coping - Once Weathered - 14" | £32.89 | 41 | 76 | 356 | 1,000 | |
| WO16 | Wall Coping - Once Weathered - 16" | £40.48 | 51 | 76 | 406 | 1,000 | |
| WO18 | Wall Coping - Once Weathered - 18" | £46.81 | 52 | 76 | 457 | 1,000 | |
| WO20 | Wall Coping - Once Weathered - 20" | £58.19 | 70 | 89 | 508 | 1,000 | |
| WO22 | Wall Coping - Once Weathered - 22" | £68.31 | 77 | 89 | 559 | 1,000 | |
| WO24 | Wall Coping - Once Weathered - 24" | £73.37 | 84 | 89 | 610 | 1,000 | |

| | | | | | | | |
|------|-------------------------------------|--------|----|-----|-----|-------|--|
| WT8 | Wall Coping - Twice Weathered - 8" | £24.67 | 19 | 64 | 203 | 1,000 | |
| WT10 | Wall Coping - Twice Weathered - 10" | £27.83 | 26 | 76 | 254 | 1,000 | |
| WT12 | Wall Coping - Twice Weathered - 12" | £31.63 | 49 | 124 | 311 | 1,000 | |
| WT14 | Wall Coping - Twice Weathered - 14" | £35.42 | 40 | 73 | 359 | 1,000 | |
| WT16 | Wall Coping - Twice Weathered - 16" | £44.28 | 46 | 76 | 406 | 1,000 | |
| WT18 | Wall Coping - Twice Weathered - 18" | £48.07 | 52 | 76 | 457 | 1,000 | |
| WT20 | Wall Coping - Twice Weathered - 20" | £60.72 | 58 | 76 | 508 | 1,000 | |
| WT22 | Wall Coping - Twice Weathered - 22" | £70.84 | 77 | 89 | 559 | 1,000 | |
| WT24 | Wall Coping - Twice Weathered - 24" | £78.43 | 91 | 102 | 610 | 1,000 | |

Page 4.19

| | | | | | | | |
|------|------------------------------------|--------|----|----|-----|-------|--|
| WF8 | Wall Coping - Flat Decorated - 8" | £24.67 | 18 | 51 | 203 | 1,000 | |
| WF10 | Wall Coping - Flat Decorated - 10" | £27.83 | 22 | 51 | 254 | 1,000 | |

Prices valid until 01/01/10

Appendix

| Code | Name | Price Excl. VAT | Weight (Kg) | Height (mm) | Width/ length 1 | Width/ length 2 | Comments |
|------------------|--|--------------------|----------------|----------------|--------------------|--------------------|---------------|
| WF12 | Wall Coping - Flat Decorated - 12" | £31.63 | 27 | 51 | 305 | 1,000 | |
| WF14 | Wall Coping - Flat Decorated - 14" | £35.42 | 39 | 64 | 356 | 1,000 | |
| WF16 | Wall Coping - Flat Decorated - 16" | £44.28 | 44 | 64 | 406 | 1,000 | |
| WF18 | Wall Coping - Flat Decorated - 18" | £48.07 | 50 | 64 | 457 | 1,000 | |
| WF20 | Wall Coping - Flat Decorated - 20" | £60.72 | 66 | 76 | 508 | 1,000 | |
| WF22 | Wall Coping - Flat Decorated - 22" | £70.84 | 73 | 76 | 559 | 1,000 | |
| WF24 | Wall Coping - Flat Decorated - 24" | £78.43 | 79 | 76 | 610 | 1,000 | |
| WD8 | Wall Coping -2 Weathered/Decorated - 8" | £26.57 | 18 | 64 | 203 | 1,000 | |
| WD10 | Wall Coping -2 Weathered/Decorated - 10" | £30.36 | 25 | 76 | 254 | 1,000 | |
| WD12 | Wall Coping -2 Weathered/Decorated - 12" | £34.16 | 47 | 124 | 311 | 1,000 | |
| WD14 | Wall Coping -2 Weathered/Decorated - 14" | £40.48 | 38 | 73 | 359 | 1,000 | |
| WD16 | Wall Coping -2 Weathered/Decorated - 16" | £45.54 | 44 | 76 | 406 | 1,000 | |
| WD18 | Wall Coping -2 Weathered/Decorated - 18" | £50.60 | 50 | 76 | 457 | 1,000 | |
| WD20 | Wall Coping -2 Weathered/Decorated - 20" | £63.25 | 55 | 76 | 508 | 1,000 | |
| WD22 | Wall Coping -2 Weathered/Decorated - 22" | £73.37 | 73 | 89 | 559 | 1,000 | |
| WD24 | Wall Coping -2 Weathered/Decorated - 24" | £83.49 | 87 | 102 | 610 | 1,000 | |
| <i>Page 4.20</i> | | | | | | | |
| WCG1 | Wall Coping - Gothic | £56.93 | 37 | 162 | 300 | 800 | |
| WCG2 | Wall Coping - Rail | £32.89 | 21 | 108 | 190 | 800 | |
| WCG3 | Wall Coping - Ridged | £37.95 | 34 | 175 | 250 | 878 | |
| WCG4 | Wall Under Coping | £78.43 | 88 | 150 | 500 | 878 | Use with WCG3 |
| <i>Page 4.21</i> | | | | | | | |
| WCG1 | Wall Coping - Gothic | £56.93 | 37 | 162 | 300 | 800 | |
| WP11 | Wall Plinth (Half) | £50.60 | 46 | 174 | 247 | 1,000 | |
| BS31 | Gothic Quatrefoil Only | £91.08 | 64 | 552 | 183 | 552 | |
| GP80 | <i>See page 4.15</i> | | | | | | |

Prices valid until 01/01/10