

CRANBORNE STONE

ARCHITECTURAL & GARDEN ORNAMENT

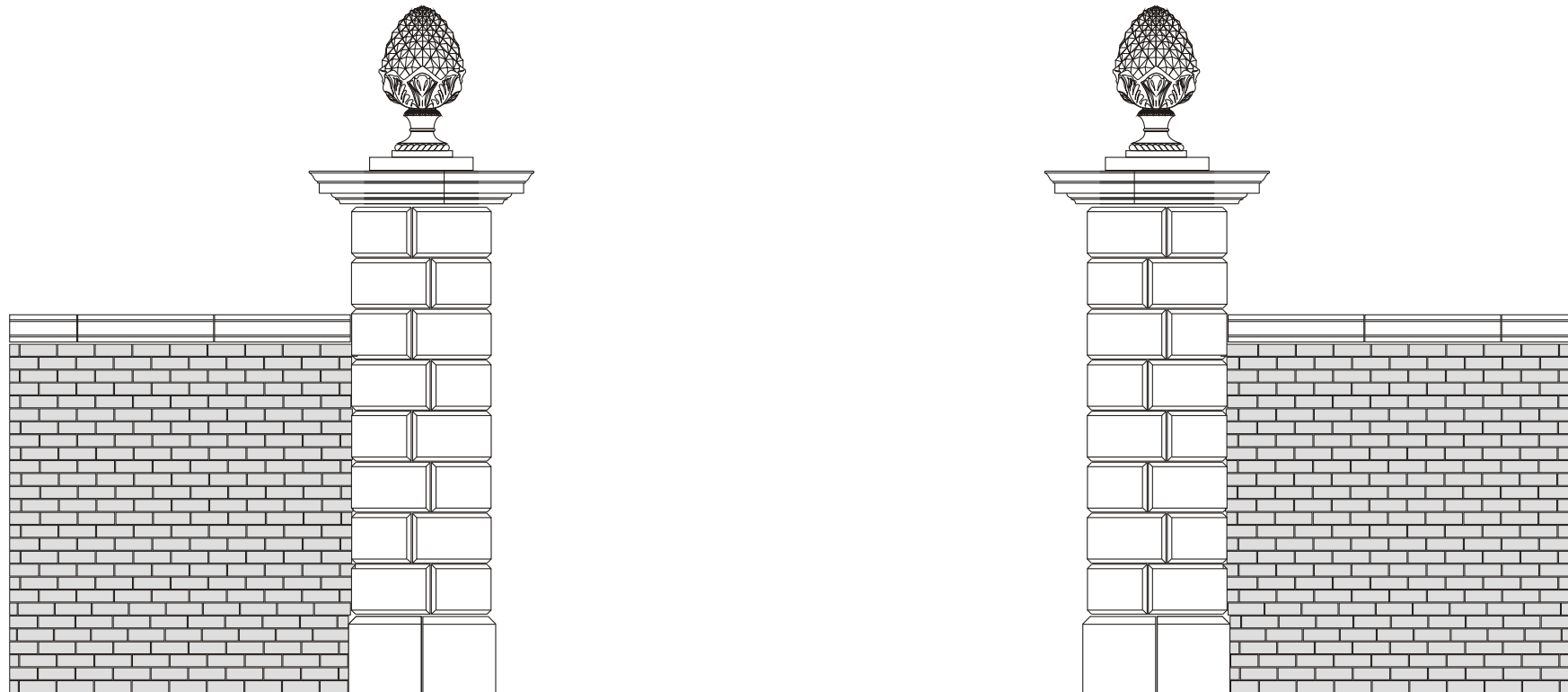

WALLS, PIERS AND FINIALS

Walls, Piers and Finials: Contents.

	page
Introduction	4.1
Balls and bases	4.2
Obelisks and pedestals	4.4
Pier caps: flat topped	4.5
Pier caps: weathered	4.7
Pier cap and finial combinations	4.10
Gate piers	4.13
Wall copings	4.17
Gothic wall	4.21
Appendix - product details	4.22

Walls, Piers and Finials: Introduction

Material

All items are cast by hand in reconstituted stone using the dry cast method. Casts are porous unless treated and frost proof.

Colour

Casts are available in three standard finishes: Portland White, Bath Yellow and Devon Red. All finishes age naturally taking on, over time, the patina of the surrounding lichens and mosses. A wide range of other colours and shades are available at a small additional cost.

Availability

Most architectural items are cast to order. Availability and delivery cost will be noted in all quotations.

Quotations

Please ask for a quotation - we can almost always return a firm quotation on the same day indicating price, delivery cost and availability.

Assembly

Gate piers and pedestals should be placed on a level footing of 8:1 sand to cement. Gate piers are hollow and will require reinforcements to support gates.

Prices and terms

All prices exclude VAT and delivery and are valid to 31/12/06. With the exception of account customers, or by prior agreement, payment is expected in full with each order.

Weights

All weights are approximate. Pier caps larger than 20" are partially hollow and the weights indicated are maximum weights.

Delivery

Delivery can be arranged to all destinations - including overseas destinations. Please ask for a quotation.

Bespoke work

Cranborne Stone has extensive experience of realising bespoke designs quickly and economically - please ask for a quotation.

Version

April 2006

Balls and Bases. 9" and 12" Balls.

Scale 1:10

9" ball (F090) on ...

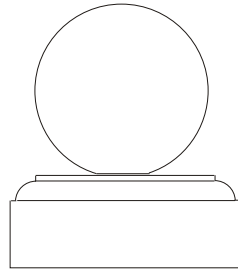

Plinth UP06P
Plinth width 303mm
Plinth height 122mm
£21.28 20Kg

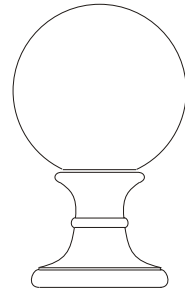

Round base F092
Base width 178mm
Base height 152mm
£20.43 4kg

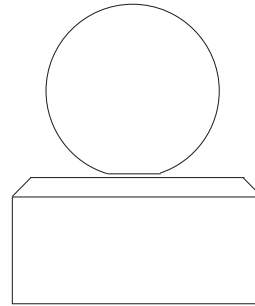

Chamfered block UP11
Base width 330mm
Base height 165mm
£21.28 32Kg

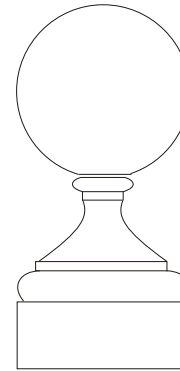

Square base 9" F121
Base width 229mm
Base height 254mm
£19.57 16Kg

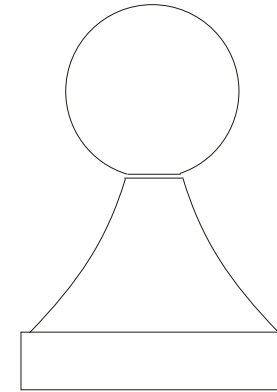

Sloping base F093
Base width 356mm
Base height 279mm
£22.13 28Kg

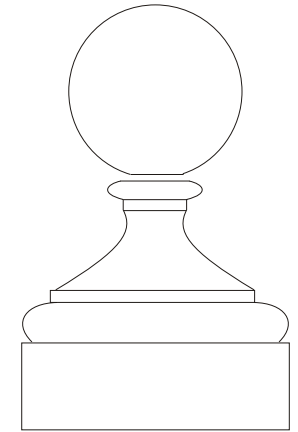

Square base 14" F171
Base width 356mm
Base height 330mm
£42.55 32Kg

12" ball (F120) on ...

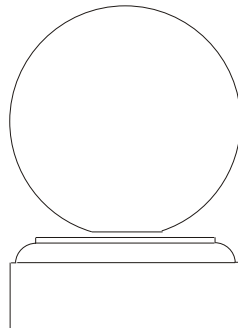

Plinth UP06P
Plinth width 303mm
Plinth height 122mm
£21.28 20Kg

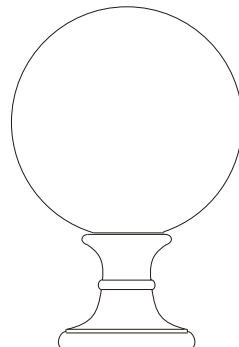

Round base F092
Base width 178mm
Base height 152mm
£20.43 4Kg

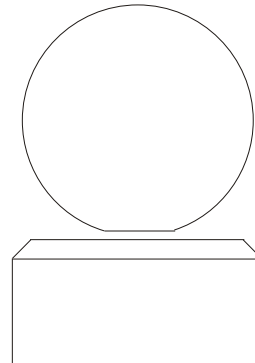

Chamfered block UP11
Base width 330mm
Base height 165mm
£21.28 32Kg

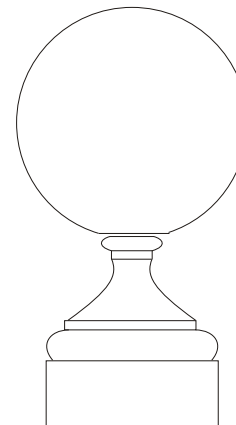

Square base 9" F121
Base width 229mm
Base height 254mm
£19.57 16Kg

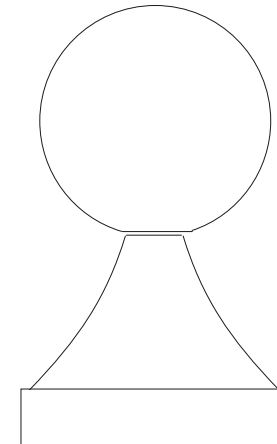

Sloping base F093
Base width 356mm
Base height 279mm
£22.13 28Kg

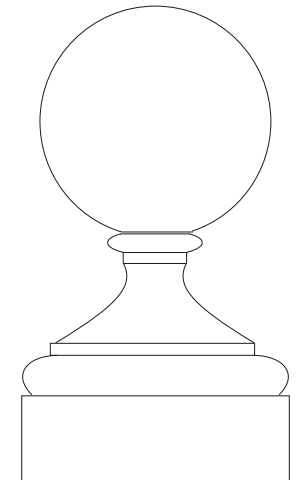

Square base 13" F171
Base width 356mm
Base height 330mm
£42.55 32Kg

17" Ball and Pineapple

Scale 1:10

17" ball (F170) on ...

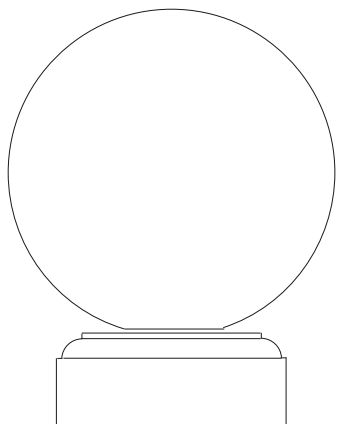
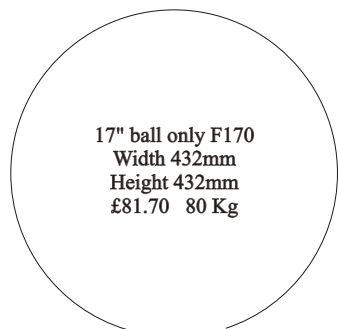

Plinth UP06P
Plinth width 303mm
Plinth height 122mm
£21.28 20Kg

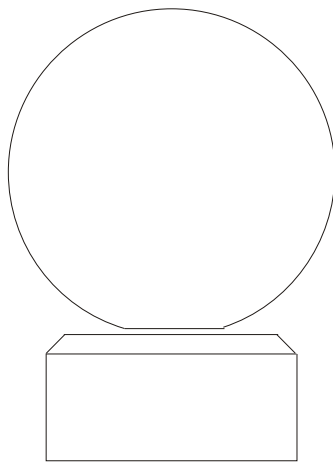

Champhered block UP11
Base width 330mm
Base height 165mm
£21.28 32Kg

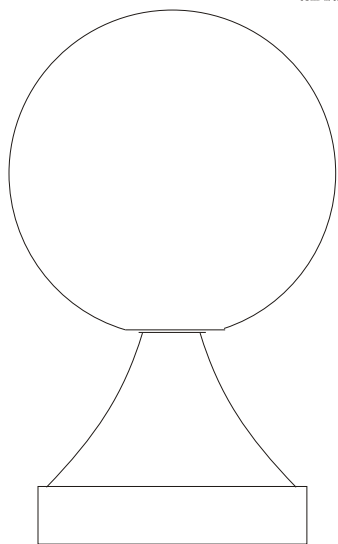

Sloping base F093
Base width 356mm
Base height 279mm
£22.13 28Kg

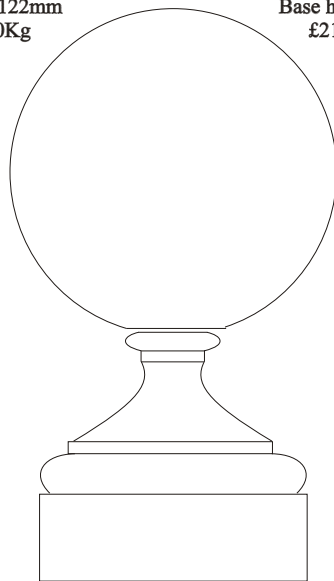

Square base 14" F171
Base width 356mm
Base height 330mm
£42.55 32Kg

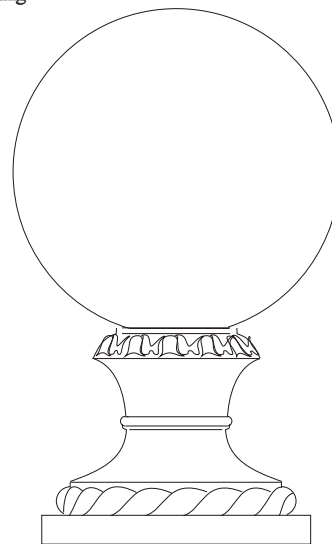

Rope pattern base F002B
Base width 356mm
Base height 277mm
£42.55 24Kg

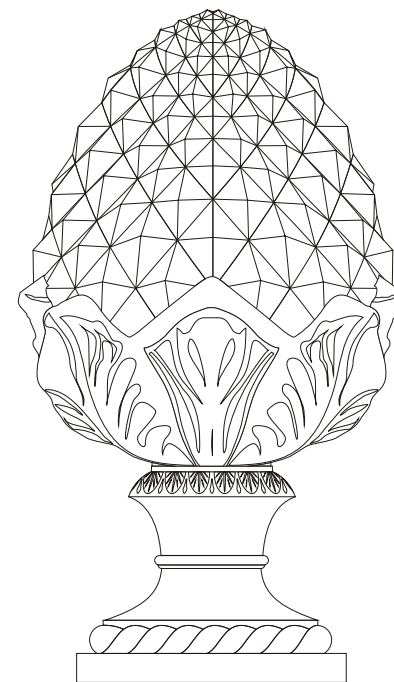

Pineapple and Base F002
£161.70 104Kg
Overall height 889mm
Base width 330mm
Maximum width 508mm

Obelisks and Pedestals.

Scale 1:20

Obelisk F001 only:
£80.85 64Kg
Height 1,105mm

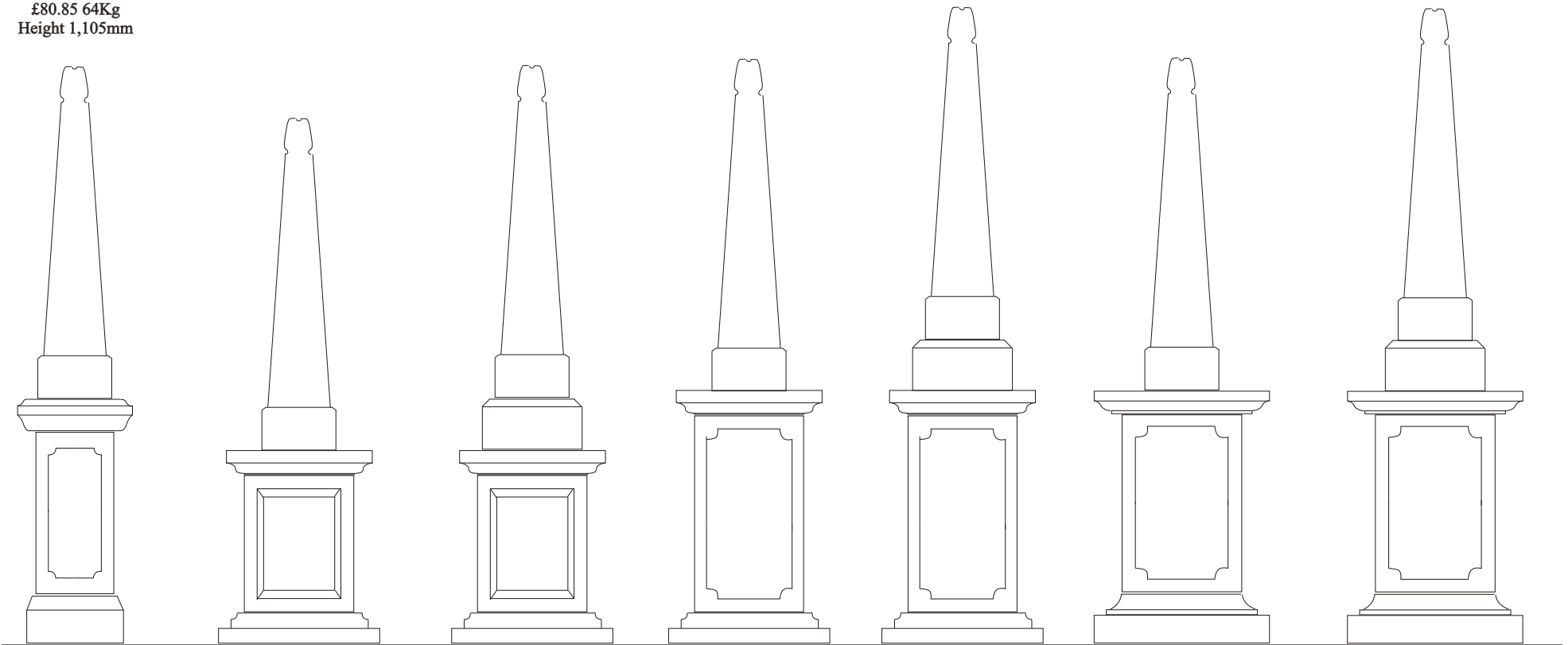

Obelisk F001 on
Georgian Pedestal UP07
£178.75 160Kg
Overall height 1,918mm

Obelisk F001 on
Panelled Pedestal UP04
£182.98 160Kg
Overall height 1,740mm

Obelisk F001 on
Chamfered Block UP11 &
Panelled Pedestal UP04
£204.26 192Kg
Height 1,905mm

Obelisk F001 on
French Pedestal UP08
£208.51 176Kg
Overall height 1,943mm

Obelisk F001 on
Chamfered Block UP11 &
French Pedestal UP08
£229.79 208Kg
Overall height 2,108mm

Obelisk F001 on
Victorian Pedestal UP09
£229.79 224Kg
Overall height 1,943mm

Obelisk F001 on
Chamfered Block UP11 &
Victorian Pedestal UP09
£251.07 256Kg
Overall height 2,108mm

Pier Caps: Flat Topped.

Scale 1:10

Flat topped - plain

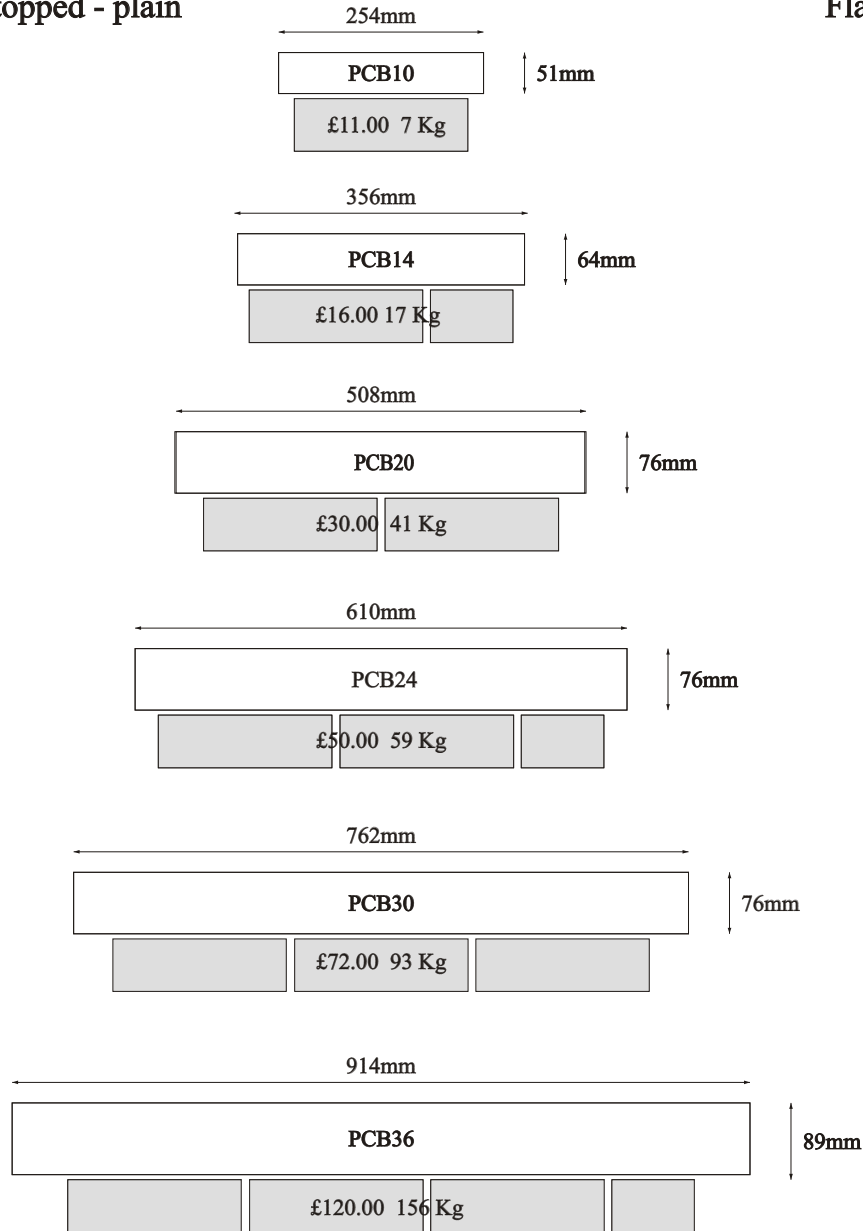

Flat topped - part weathered

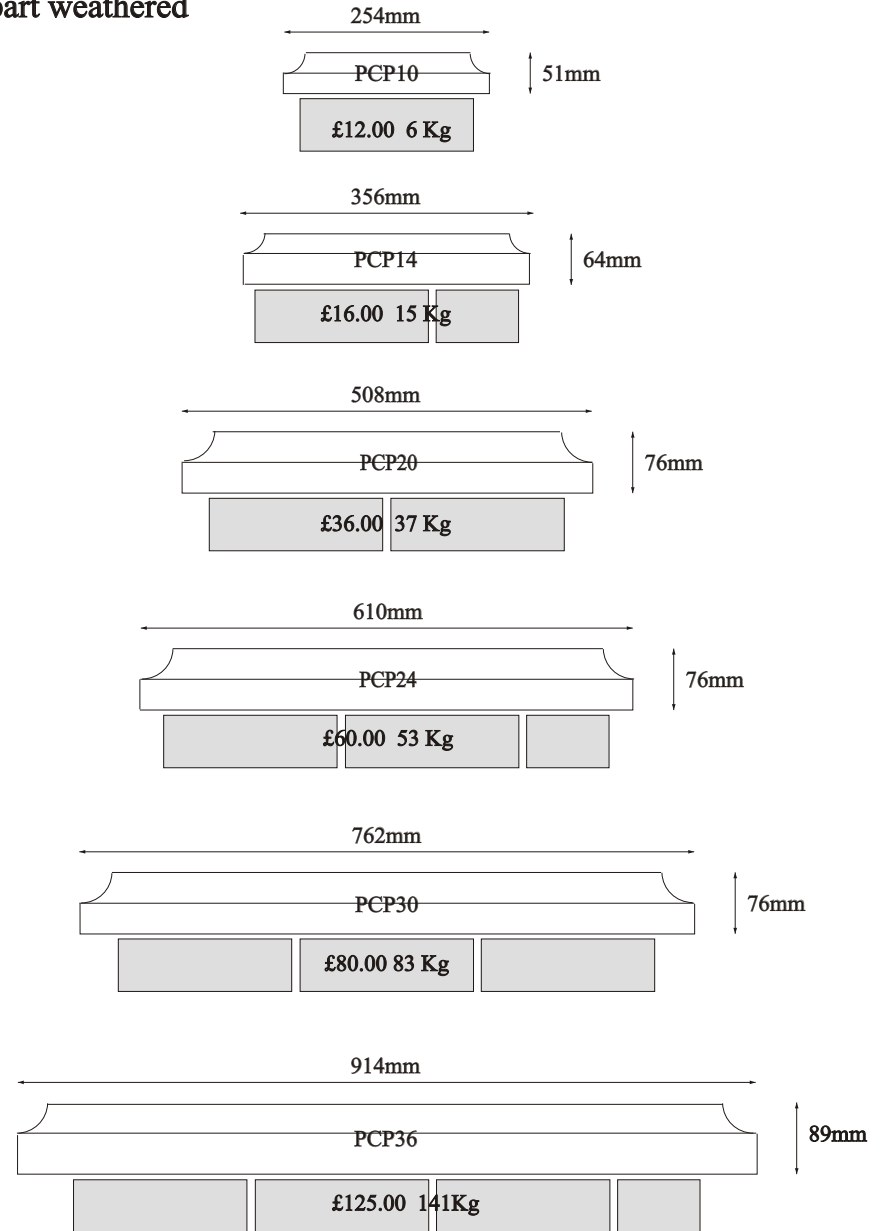

Allow 25-35mm (min) overhang, on each side, for drip channels

Pier Caps: Flat Topped - Decorated.

Scale 1:10

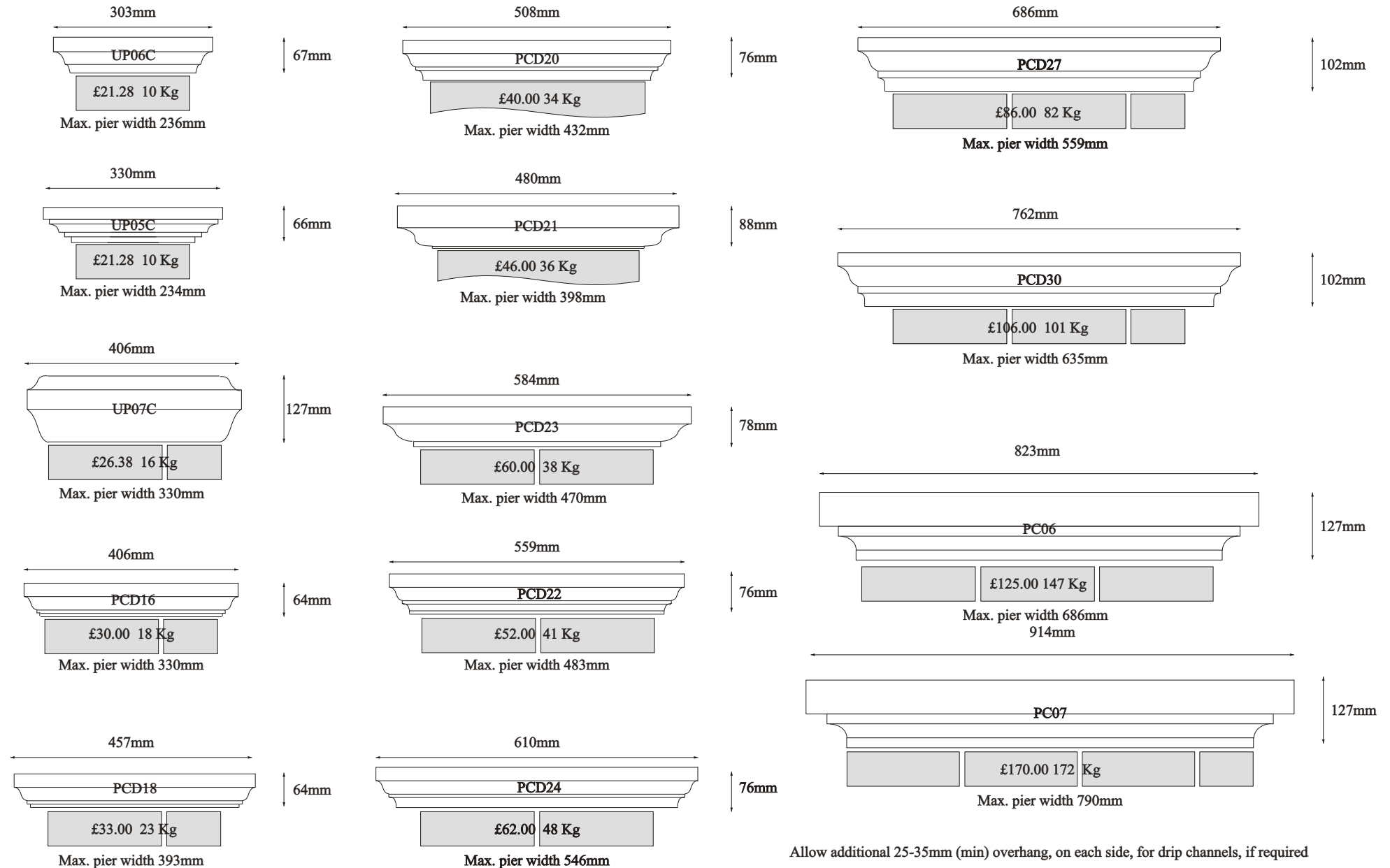

Allow additional 25-35mm (min) overhang, on each side, for drip channels, if required

Pier Caps: Weathered Plain.

Scale 1:10

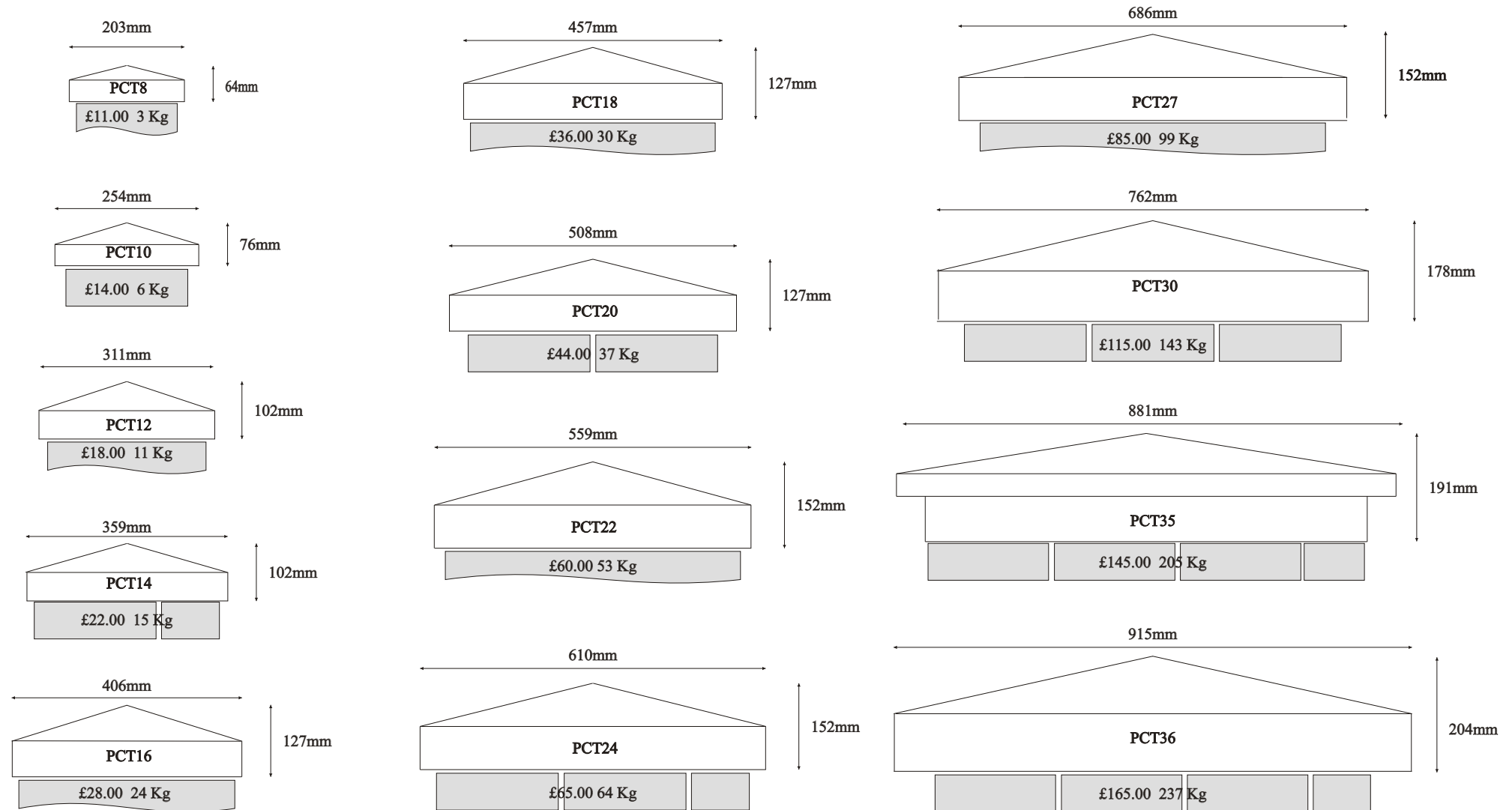

Allow 25-35mm (min) overhang, on each side, for drip channels

And PCT37 max. width 940 mm

Pier Caps: Weathered Decorated.

Scale 1:10

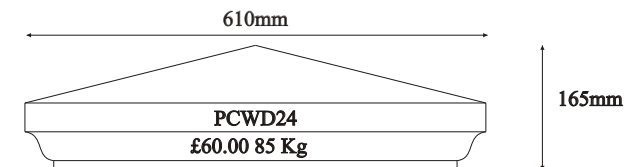
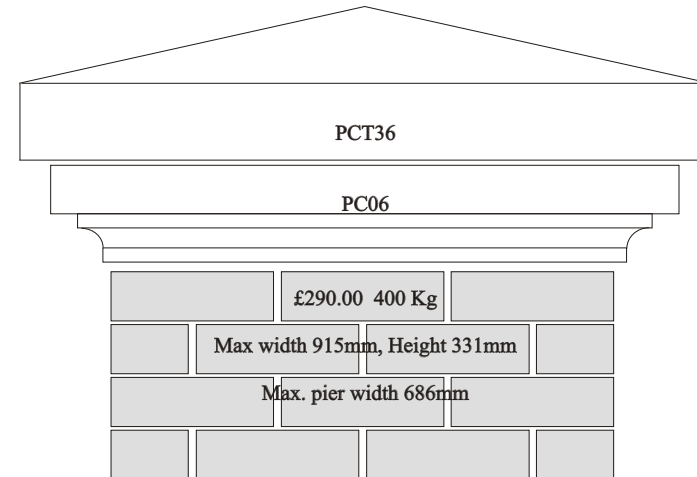
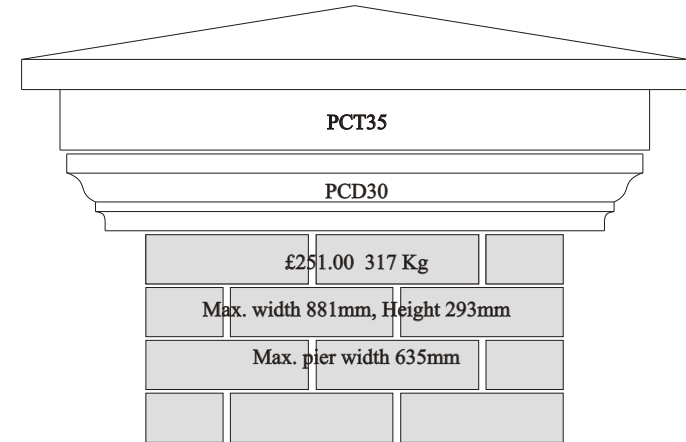
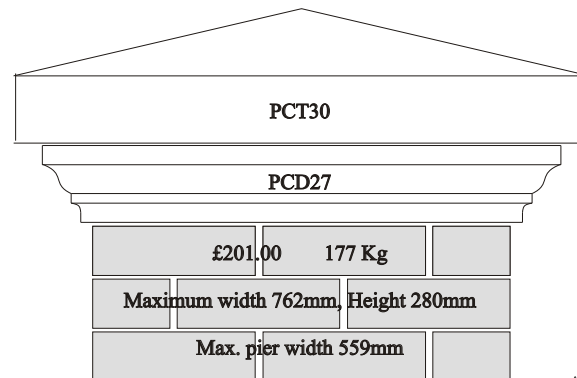
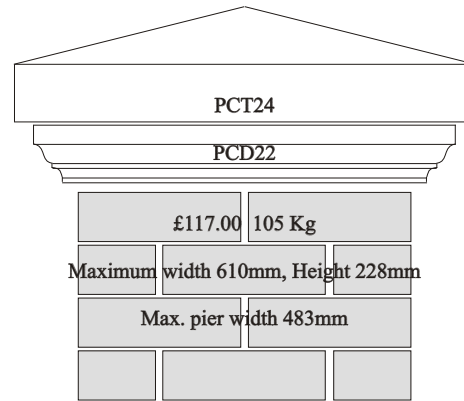
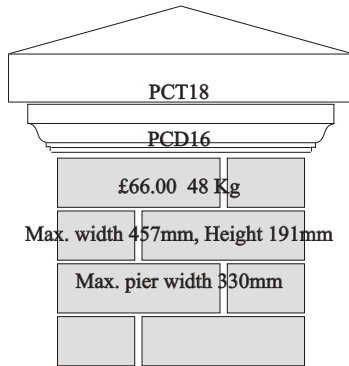
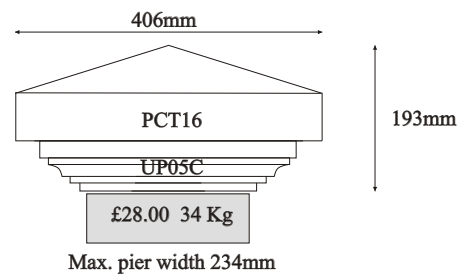
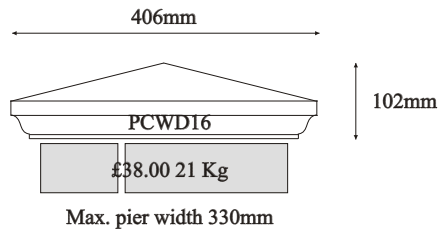
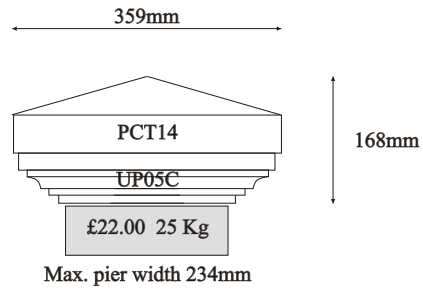
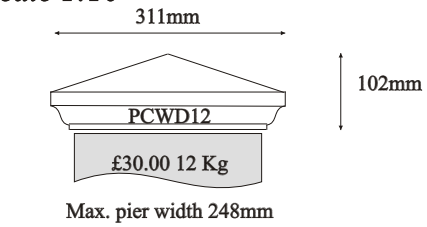

Allow additional 25-35mm (min) overhang, on each side, for drip channels, if required

Pier Caps: Half Weathered.

Scale 1:10

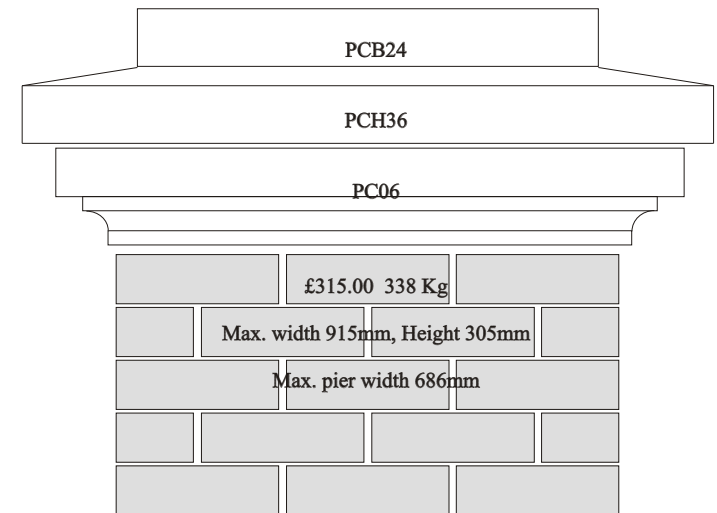
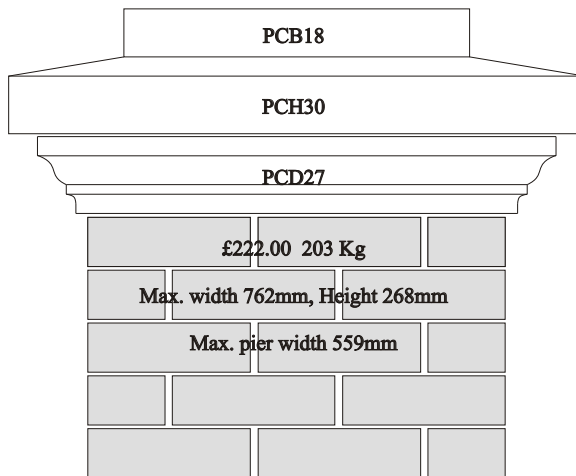
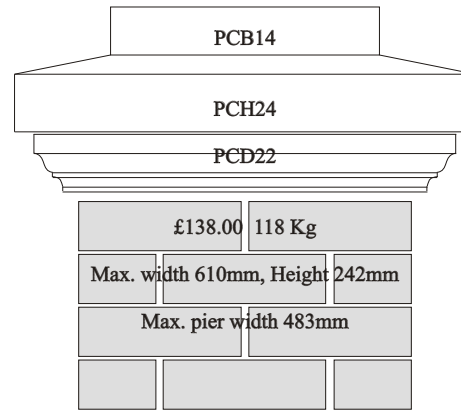
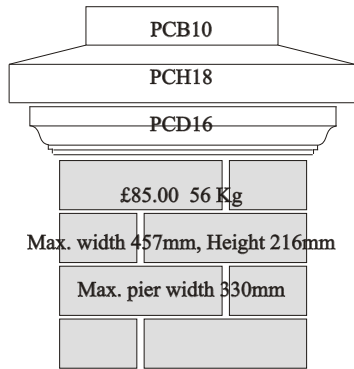

Allow additional 25-35mm (min) overhang, on each side, for drip channels, if required

Pier Cap and Finial Combinations (440mm Pier).

Scale 1:10

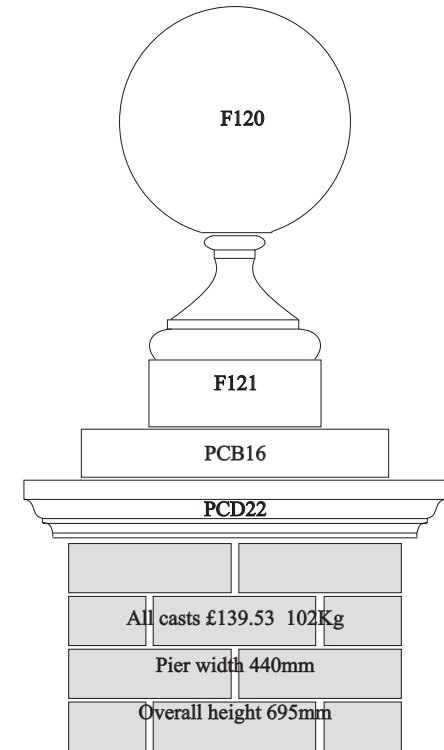
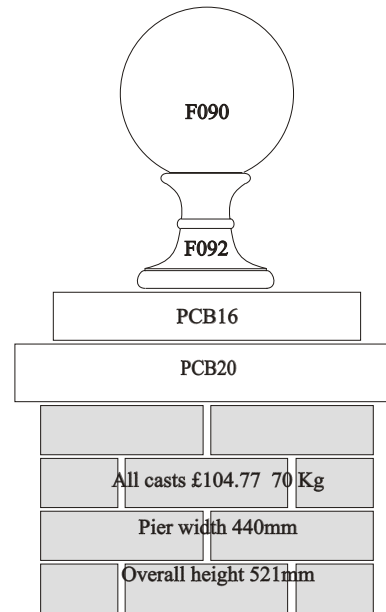
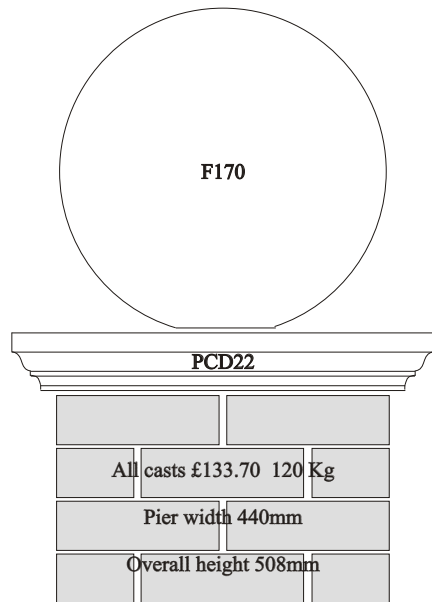

Pier Cap and Finial Combinations (552mm Pier).

Scale 1:10

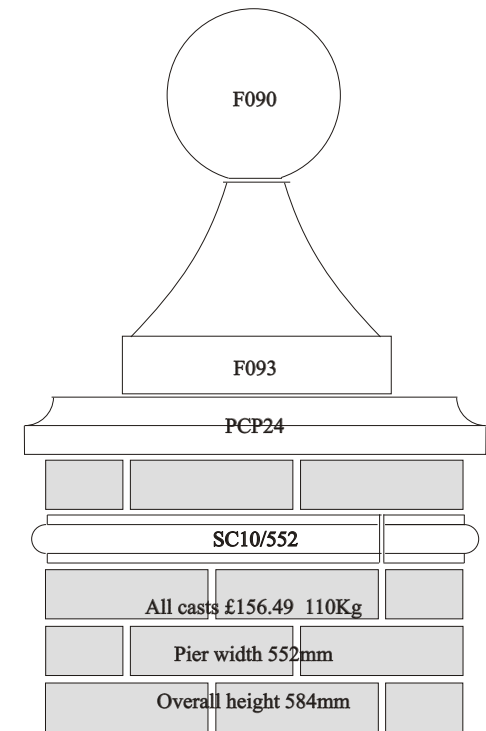
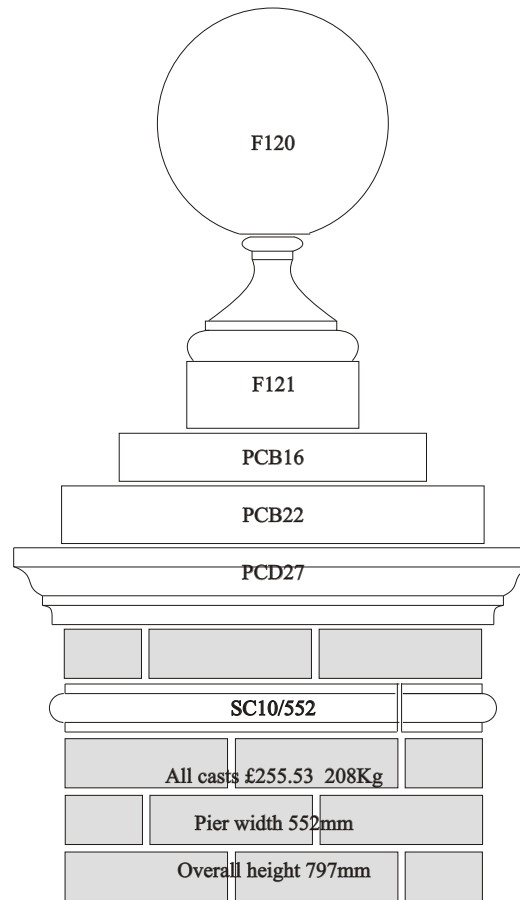
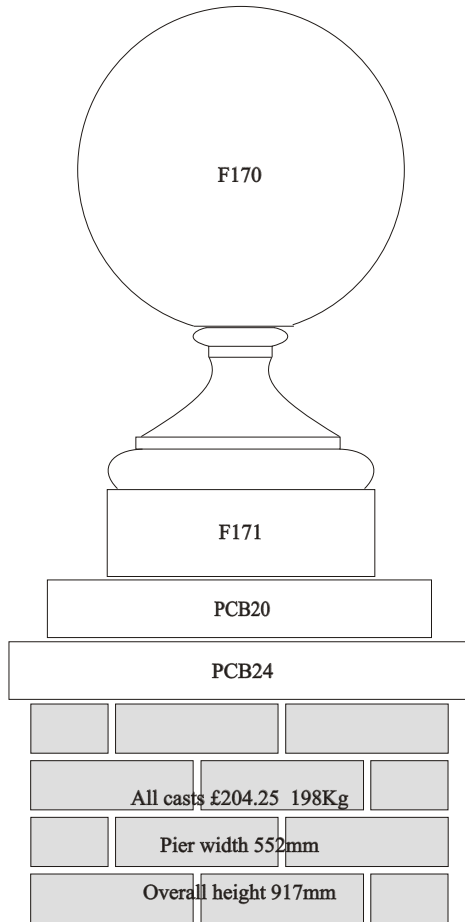

Pier Cap and Finial Combinations (665mm Pier).

Scale 1:10

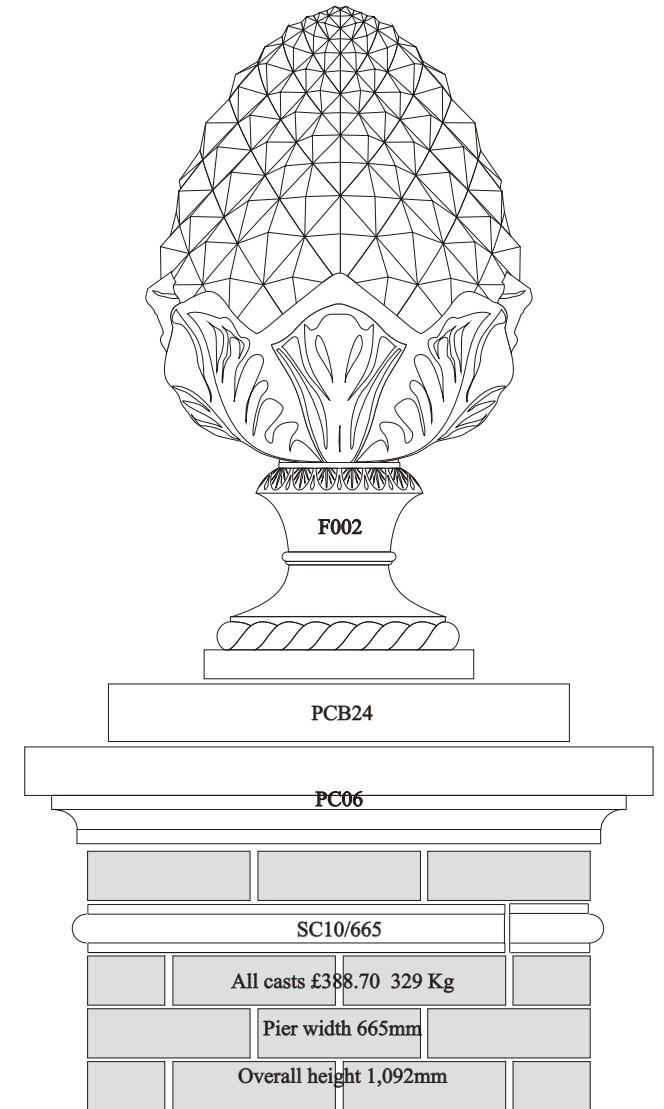
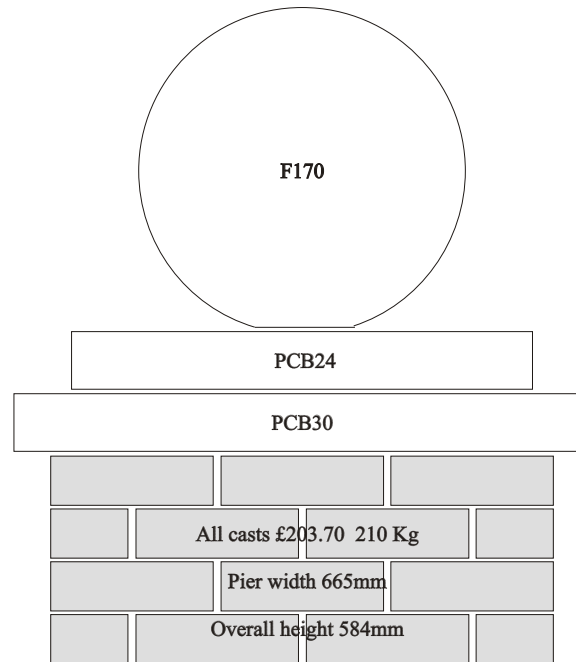
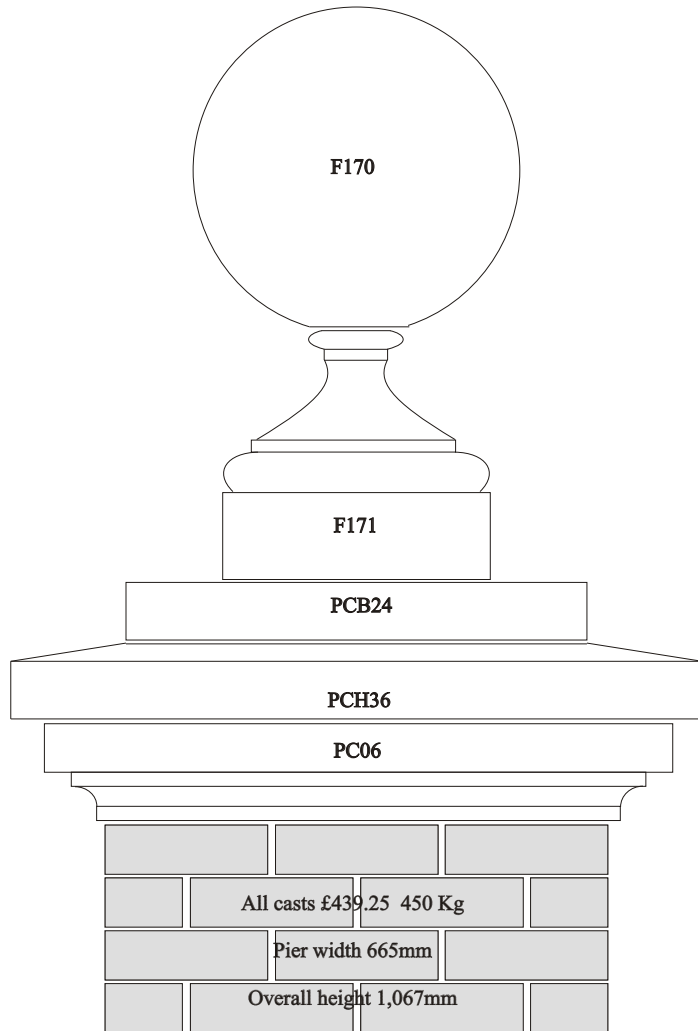

Gate Piers

Scale 1:20

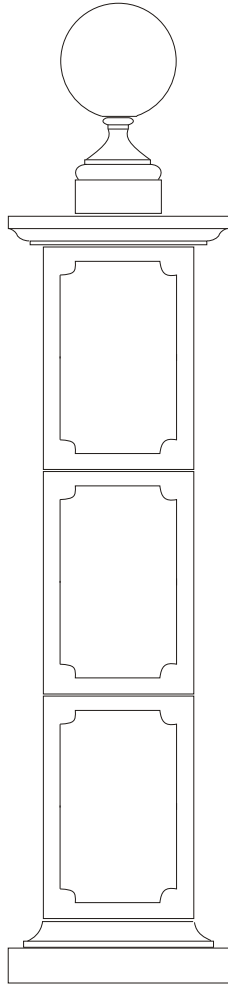

Gate Pier GP50
(Including Pier cap UP09C)
£367.40 360 Kg

Height 2,029 (including 24mm of grouting)
Extra 588mm of shaft (GP52): £88.00
Core: minimum 250mm square.

Illustrated with 12" ball F120 and Square base F121

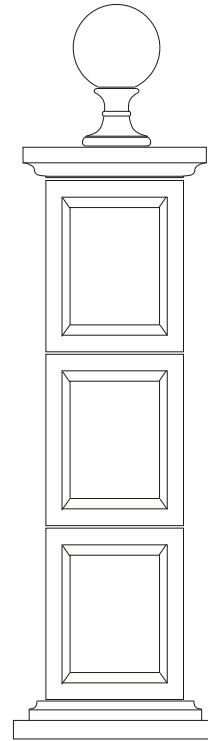

Gate Pier GP30
(Including Pier cap UP04C)
£261.80 201 Kg

Height 1,563 (including 24mm of grouting)
Extra 453mm of shaft (GP32): £55.00
Illustrated with 9" ball F090 and Round base F092

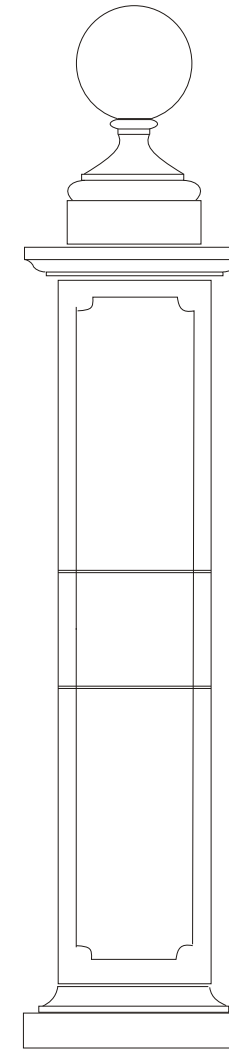

Gate Pier GP40
(Including Pier cap UP09C)
£354.20 305 Kg

Height 2,121 (including 30mm of grouting)
Extra 300mm of shaft (GP43): £57.20
Core: minimum 250mm square
Illustrated with 12" ball F120 and Square base F171

Finial details are on page 4.2. See Appendix for full details.

Gate Piers

Scale 1:20

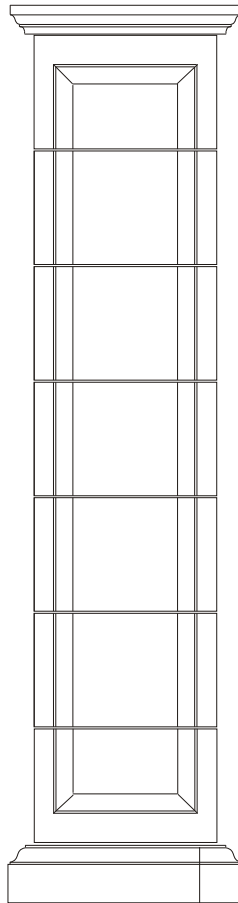

Gate Pier GP10
Including Pier cap (PCD24)
Height 2,340 (including 12mm of grouting)
£605.00 597 Kg
Extra 300mm of shaft (GP13): £66.00
Core: minimum 320mm square.

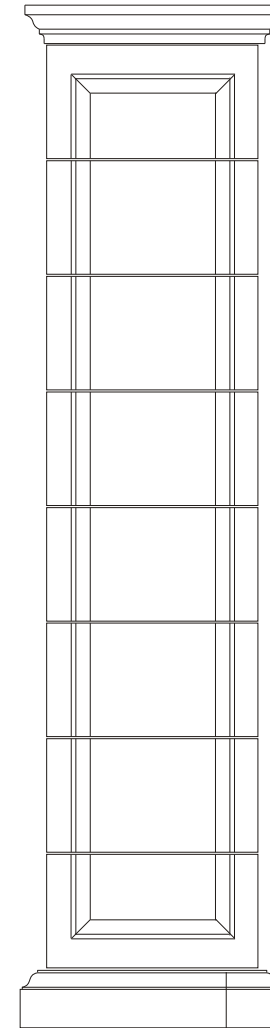

Gate Pier GP20
Including Pier cap (PCD27)
Height 2,666 (including 12mm of grouting)
£781.00 900 Kg
Extra 300mm of shaft (GP23): £77.00
Core: minimum 359mm square.

Gate Piers

Scale 1:20

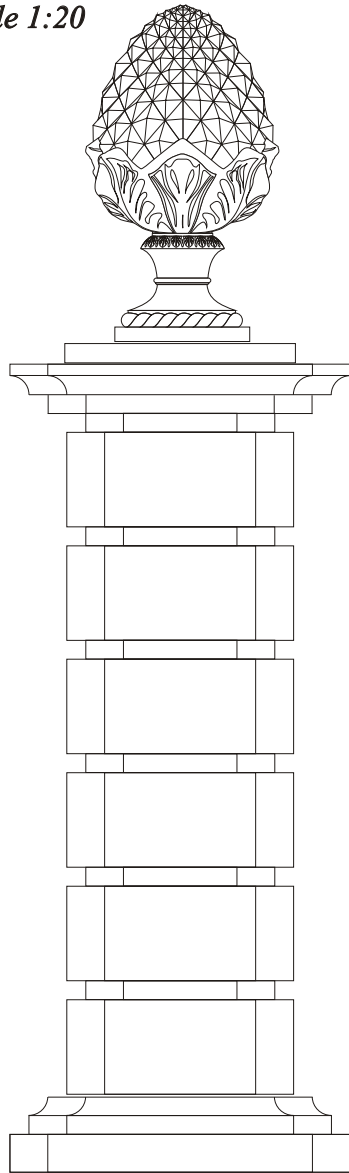

Left

Gate Pier GP70
 Including pier cap (GP73)
 Height 2,130mm
 £990.00 (773Kg)
 Extra 300mm of shaft (GP72): £110.00
 Core: minimum 200mm square
 Illustrated with F002 and PCB24

Plan

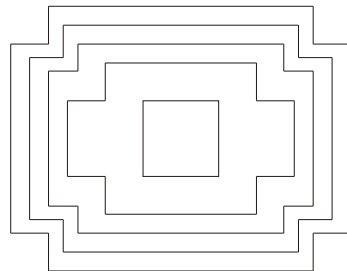

Right

Gate Pier GP80
 Height 2,274mm (excluding lower shaft)
 £990.00 (652Kg)
 Extra 300mm of shaft (GP82): £148.50
 Core diameter approximately 500mm

Plan

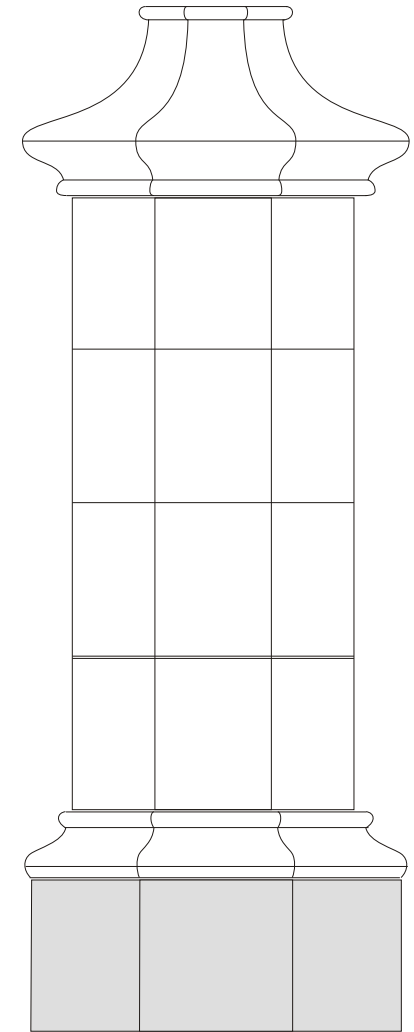
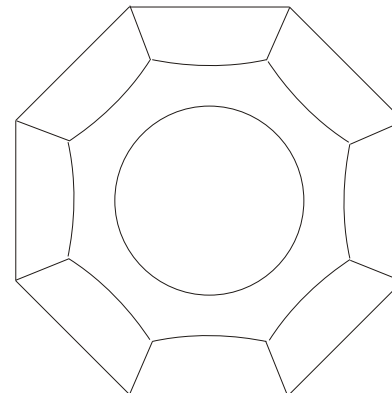

Finial details are on page 4.2. See Appendix for full details.

Gate Piers

Scale 1:20

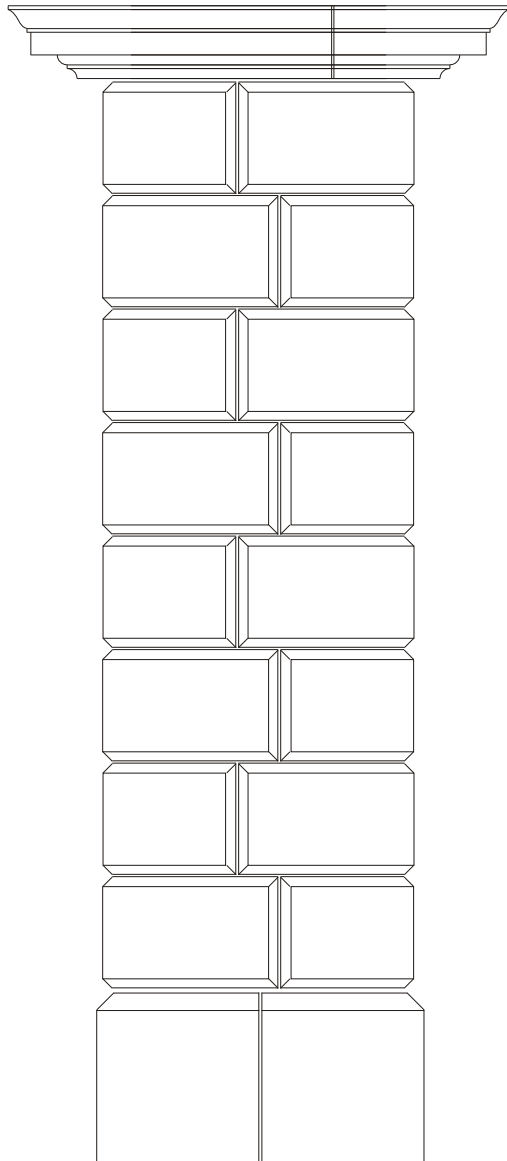

Left

Gate Pier GP60 Configuration A
Including pier cap (GP63)
Height 3,054mm (including 60mm of grouting)
£1,364.00 (2,088Kg)
Extra 294mm of shaft (GP62): £108.84
Core: minimum 562mm square

Right

Gate Pier GP60 Configuration B
Including pier cap (GP63)
Height 3,054mm (including 60mm of grouting)
£1,716.00 (2,362Kg)
Extra 294mm of shaft (GP62): £128.64
Core: minimum 675mm square

Note

A variety of gate piers can be
designed using standard components.
Please ask for details.

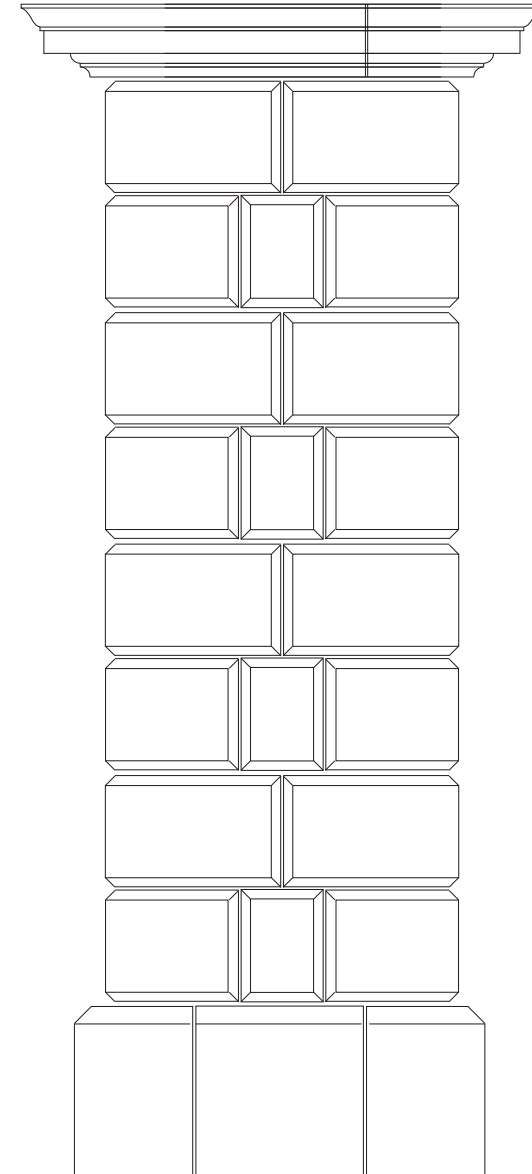

Wall Coping: Plain and Part Weathered

Scale 1:10

Plain

Part weathered

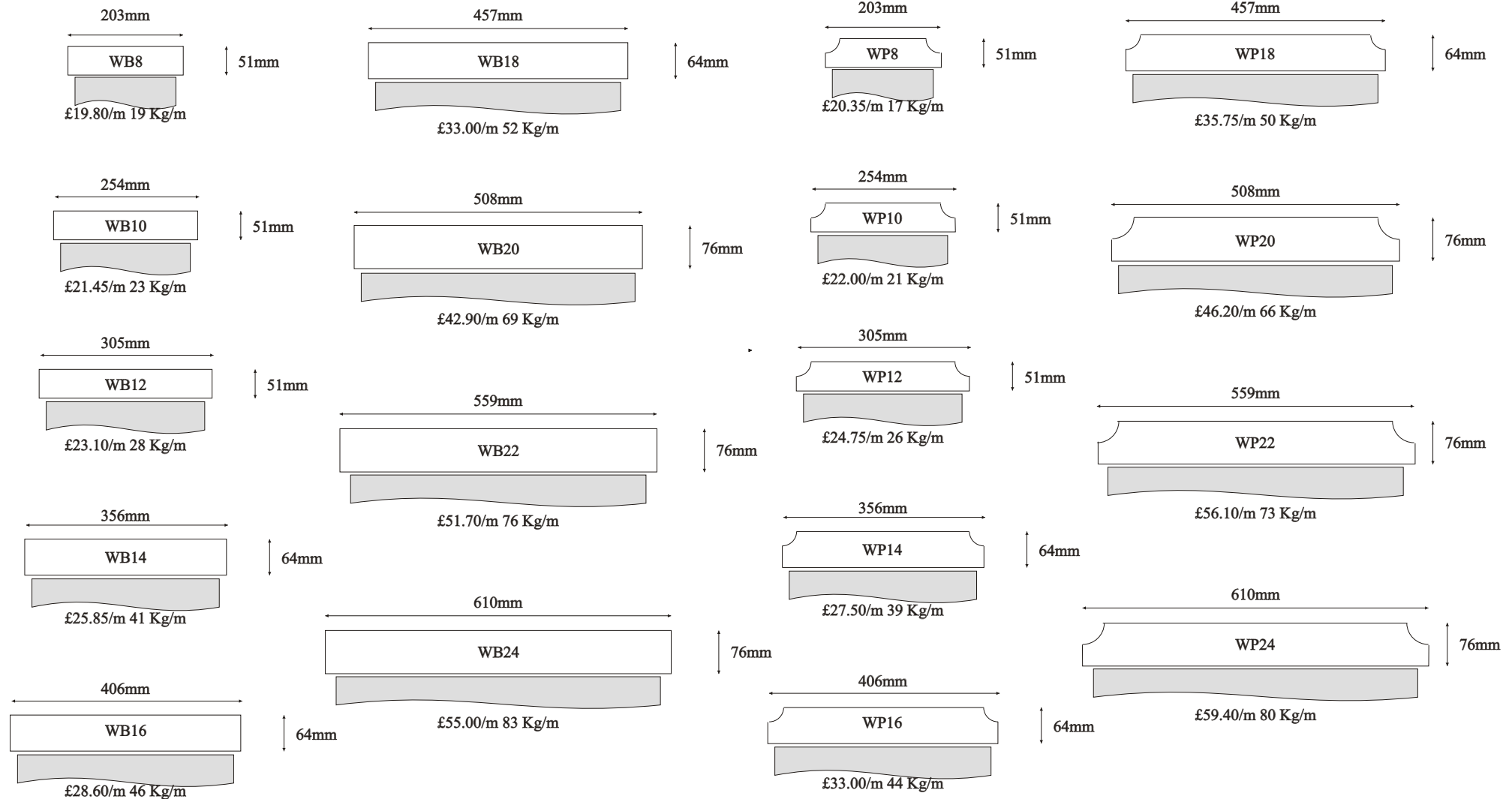

Allow 25-35mm (min) overhang, on each side, for drip channels

All copings are supplied throated. All copings are supplies in whole lengths of 1,000mm. Corner sections, curved and sloping sections are also available.

Wall Coping: Once Weathered and Twice Weathered

Scale 1:10

Once weathered

Twice weathered

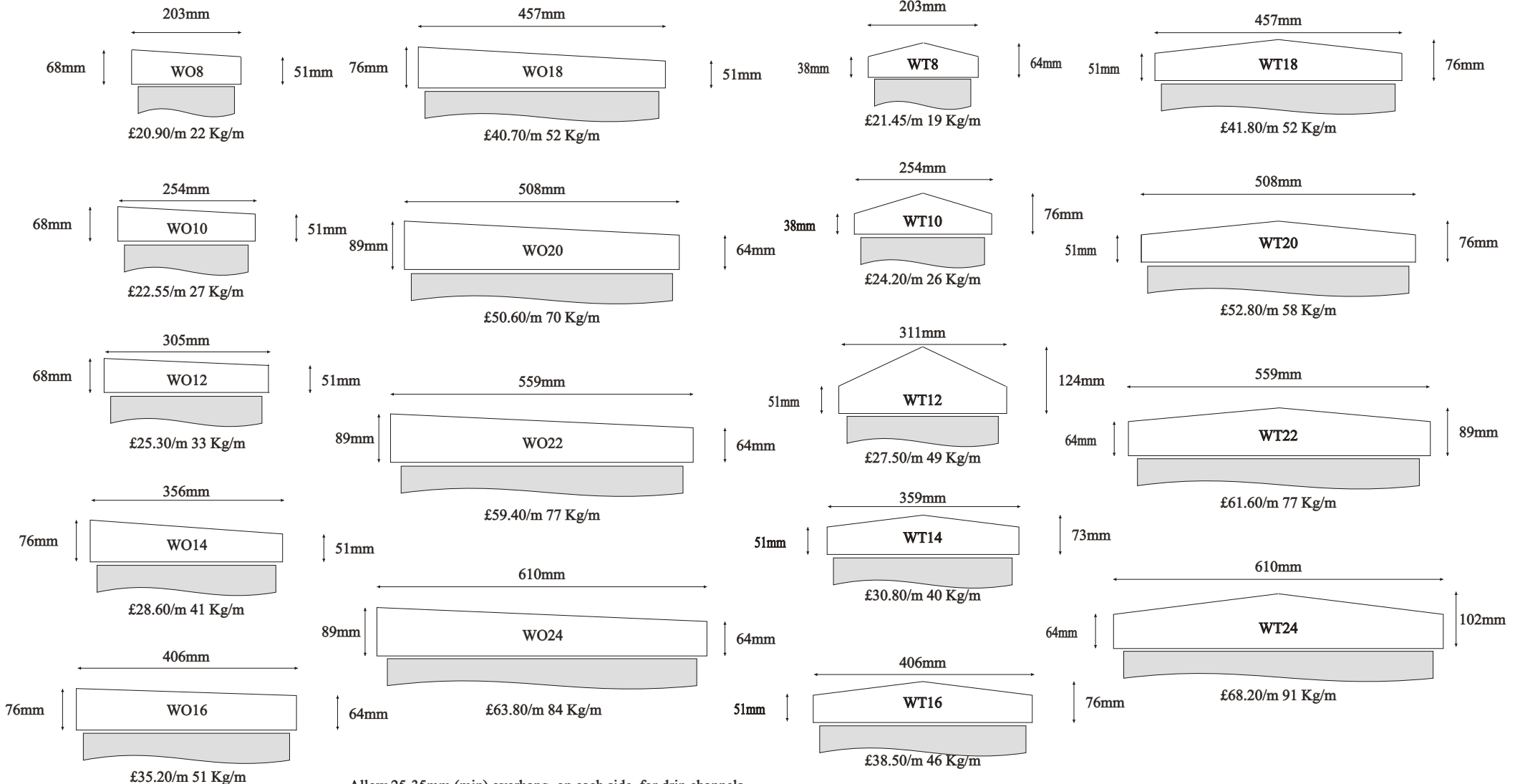

All copings are supplied throated. All copings are supplies in whole lengths of 1,000mm. Corner sections, curved and sloping sections are also available.

Wall Coping: Flat Decorated and Twice Weathered Decorated

Scale 1:10

Flat decorated

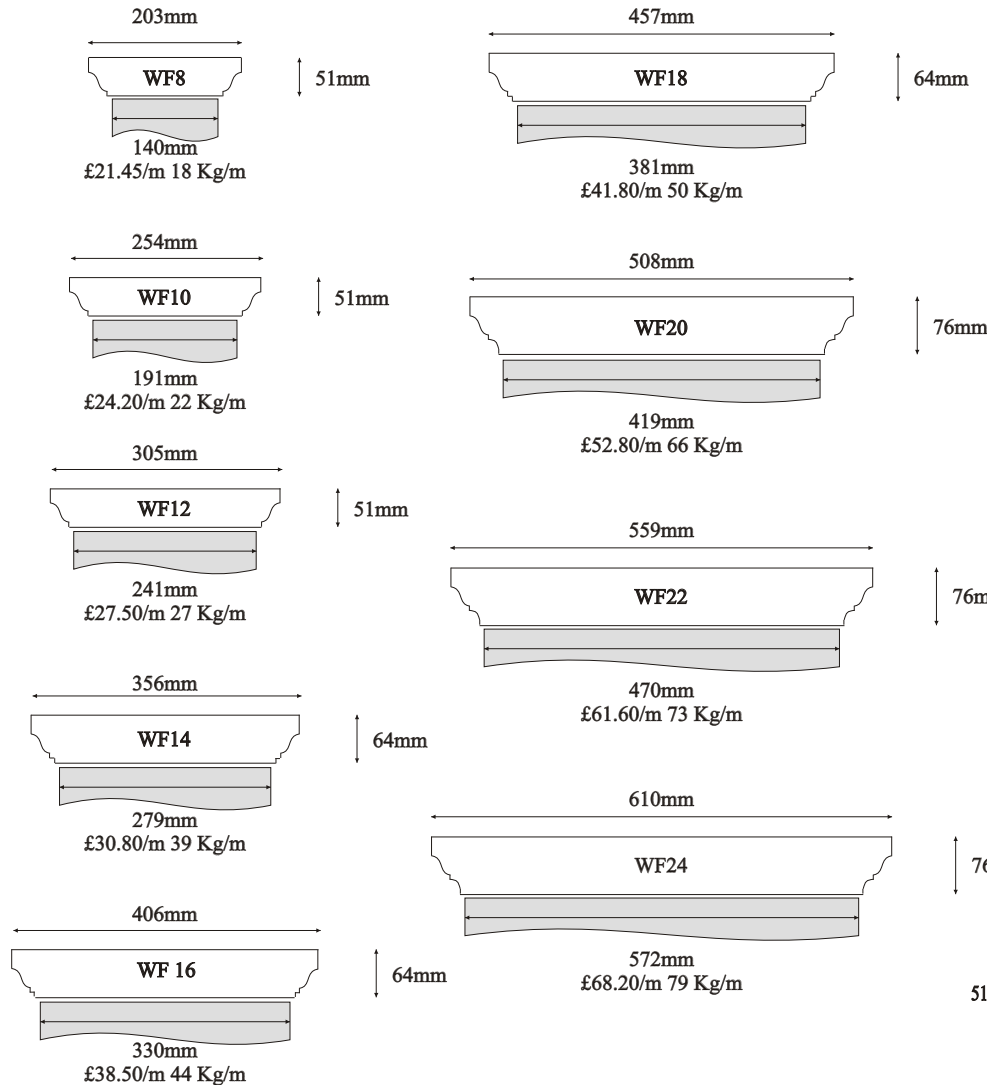

Twice weathered decorated

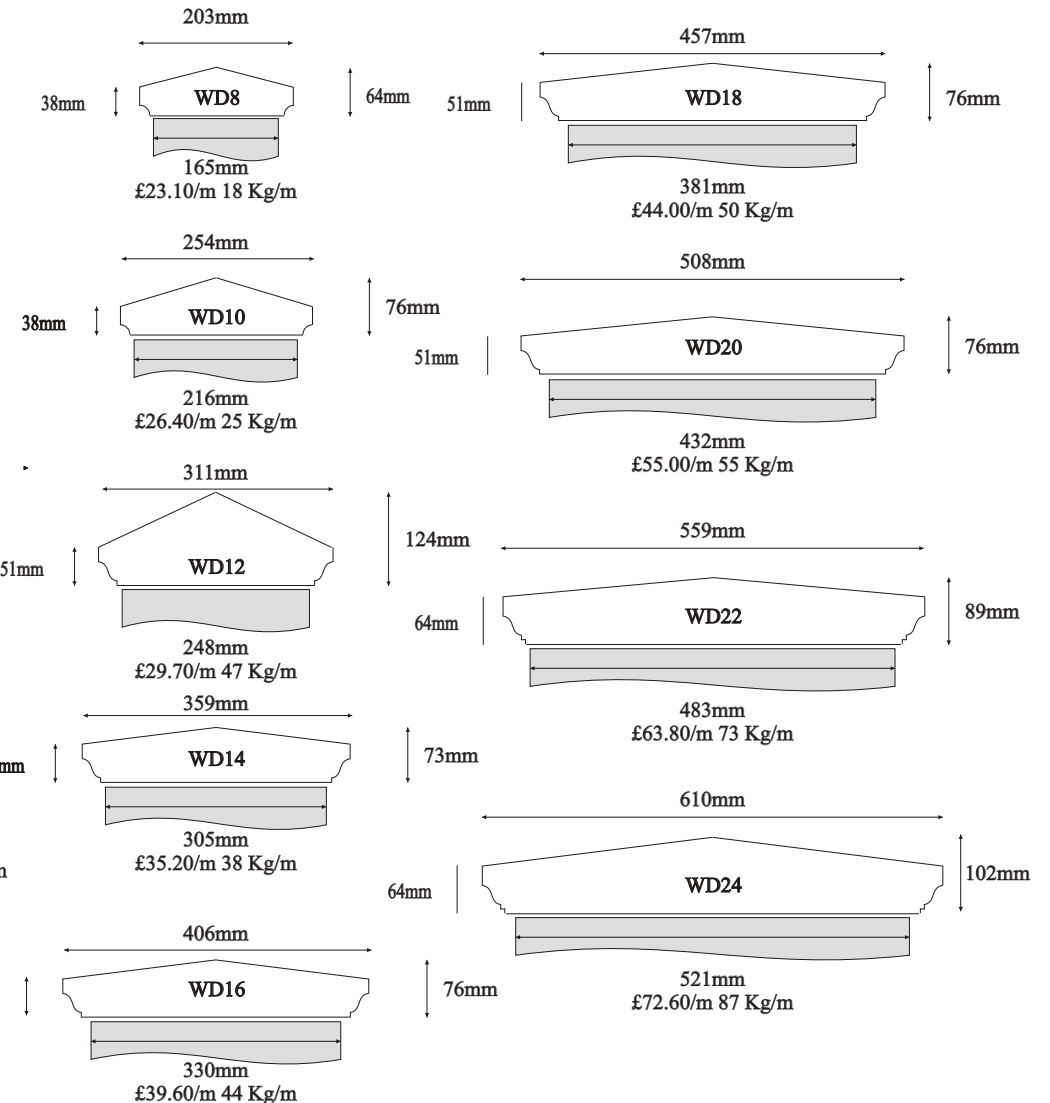

Allow 25-35mm (min) overhang, on each side, for drip channels if required

All copings are supplied throated. All copings are supplied in whole lengths of 1,000mm. Corner sections, curved and sloping sections are also available.

Miscellaneous Wall Coping

Scale 1:10

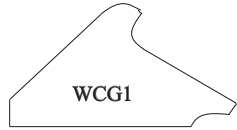

Wall coping WCG1
£49.50/m 46Kg/m
Max. width 300mm, wall width 240mm
Height 162mm *See also page 4.21*



Wall coping WCG2
£28.60/m 26Kg/m
Max. width 190mm Height 108mm

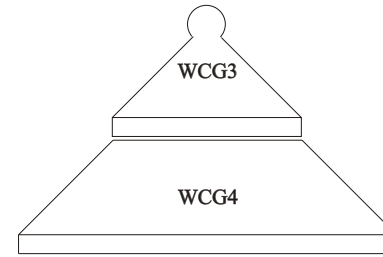

Wall coping WCG3
£33.00 per 878mm cast 34Kg
Max. width 250mm, height 175mm

Under coping WCG4
£68.20 per 878mm cast 88Kg
Max. width 500mm, height 150mm

Scale 1:20

Crenellated wall using WCG3 and WCG4

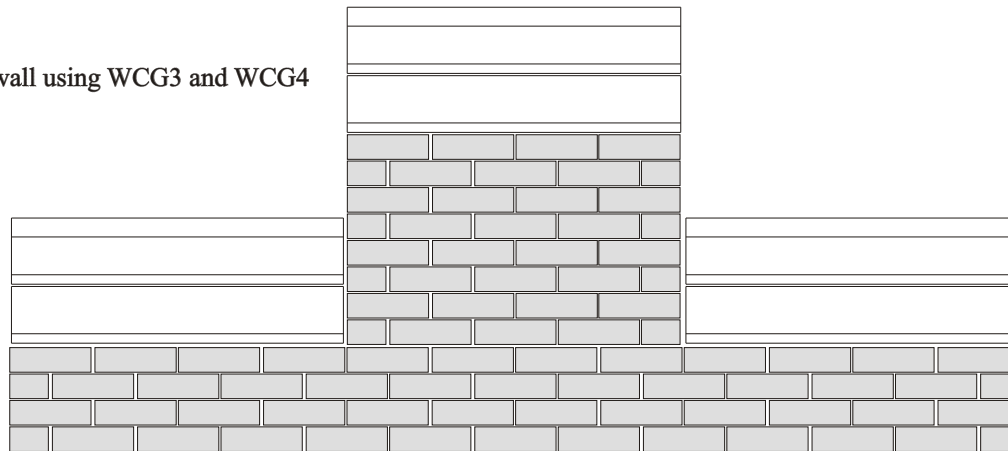

Gothic Wall

Scale 1:20

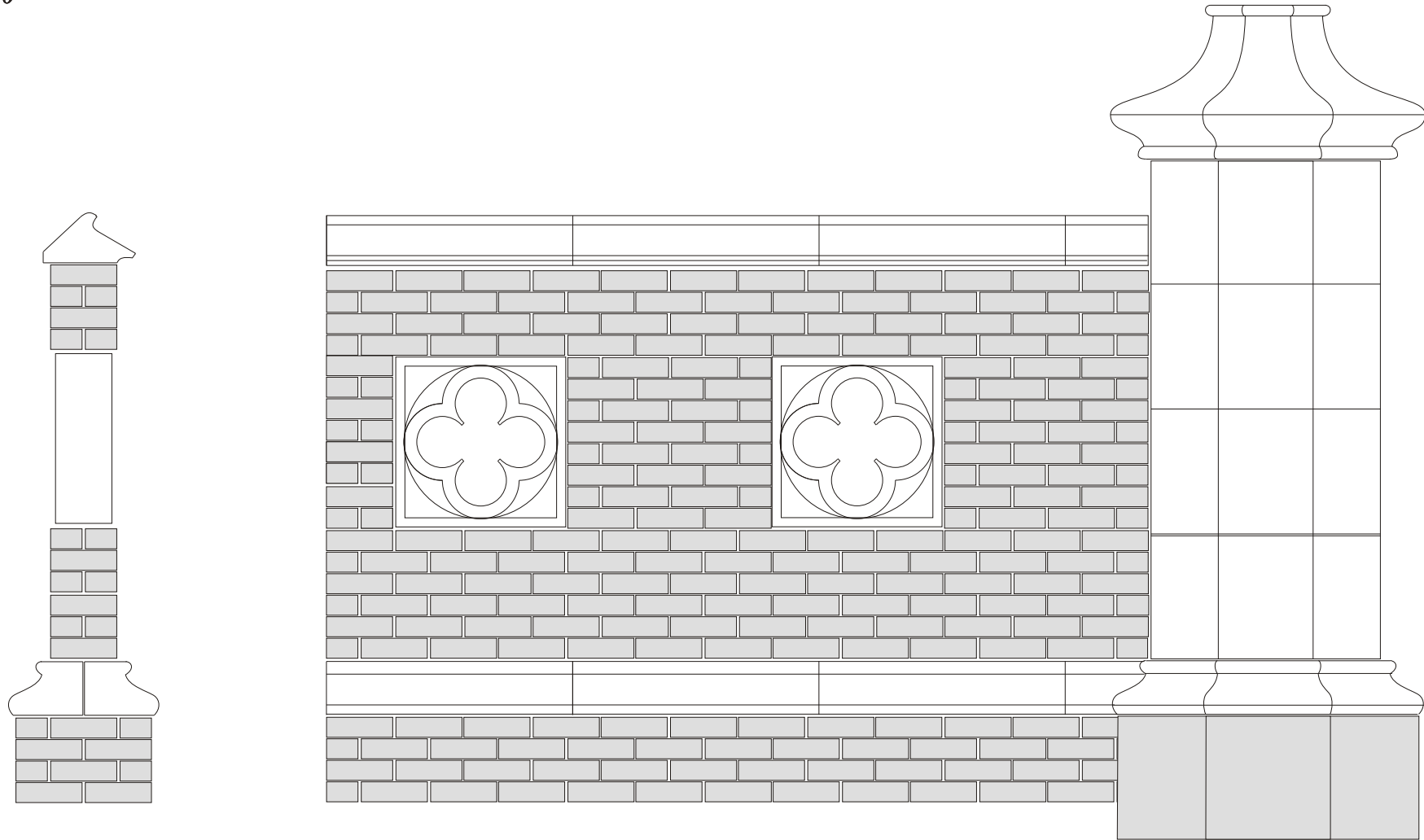

Gothic Wall.
Wall Coping WCG1, with Wall Plinth WP11 and Quatrefoils BS31
Approximately £172 per metre.
Illustrated with Gate Pier GP80 *See page 4.15*

Appendix

Code	Name	Price Excl. VAT	Weight (Kg)	Height (mm)	Width/ length 1	Width/ length 2	Comments
<i>Page 4.2</i>							
F090	9" Ball only	£32.34	12	229	229	229	
UP06P	Renaissance Plinth - plinth	£21.28	18	122	303	303	
F092	Round Base only	£20.43	4	152	178	178	
UP11	Chamfered block	£21.28	25	165	330	330	
F121	Square Base (9") only	£19.57	16	254	229	229	
F093	Sloping Base only	£22.13	28	279	356	356	
F171	Square Base (14") only	£42.55	32	330	356	356	
F120	12" Ball only	£45.96	30	301	305	305	
<i>Page 4.3</i>							
F170	17" Ball only	£81.70	80	432	432	432	
UP06P	Renaissance Plinth - plinth	£21.28	18	122	303	303	
UP11	Chamfered block	£21.28	25	165	330	330	
F093	Sloping Base only	£22.13	28	279	356	356	
F171	Square Base (14") only	£42.55	32	330	356	356	
F002B	Rope pattern base	£42.55	24	277	356	356	
F002	Pineapple and base	£161.70	104	889	508	508	2 casts
<i>Page 4.4</i>							
F001	Obelisk	£80.85	68	1,105	254	254	
UP07	Georgian Pedestal	£97.87	96	813	406	406	3 casts
UP04	Panelled Pedestal	£102.13	119	635	480	480	3 casts
UP11	Chamfered block	£21.28	25	165	330	330	
UP08	French Pedestal	£127.66	126	838	533	533	3 casts
UP09	Victorian Pedestal	£148.94	160	848	584	584	3 casts
<i>Page 4.5</i>							
PCB10	Pier cap - plain - 10"	£11.00	6	51	254	254	
PCB12	Pier cap - plain - 12"	£13.00	8	51	293	293	Not illustrated
PCB14	Pier cap - plain - 14"	£16.00	15	64	356	356	
PCB16	Pier cap - plain - 16"	£22.00	19	64	406	406	Not illustrated
PCB18	Pier cap - plain - 18"	£26.00	24	64	457	457	Not illustrated
PCB20	Pier cap - plain - 20"	£30.00	35	76	508	508	
PCB22	Pier cap - plain - 22"	£40.00	43	76	559	559	Not illustrated
PCB24	Pier cap - plain - 24"	£50.00	51	76	610	610	

Appendix

Code	Name	Price Excl. VAT	Weight (Kg)	Height (mm)	Width/ length 1	Width/ length 2	Comments
PCB30	Pier cap - plain - 30"	£72.00	79	76	762	762	
PCB36	Pier cap - plain - 36"	£120.00	134	89	914	914	
PCB40	Pier cap - plain - 40"	£150.00	165	89	1,016	1,016	Not illustrated
PCP10	Pier cap - part weathered - 10"	£12.00	6	51	254	254	
PCP14	Pier cap - part weathered - 14"	£16.00	14	64	356	356	
PCP20	Pier cap - part weathered - 20"	£36.00	34	76	508	508	
PCP24	Pier cap - part weathered - 24"	£60.00	48	76	610	610	
PCP30	Pier cap - part weathered - 30"	£80.00	75	76	762	762	
PCP36	Pier cap - part weathered - 36"	£125.00	127	89	914	914	
PCP40	Pier cap - part weathered - 40"	£160.00	157	89	1,016	1,016	Not illustrated

Page 4.6

UP06C	Renaissance Plinth - cap	£21.28	10	67	303	303	
UP05C	Classical Plinth - cap	£21.28	13	66	330	330	
UP07C	Georgian Plinth - cap	£26.38	16	127	406	406	
PCD16	Pier cap - flat decorated - 16"	£30.00	18	64	406	406	
PCD18	Pier cap - flat decorated - 18"	£33.00	23	64	457	457	
PCD20	Pier cap - flat decorated - 20"	£40.00	34	76	508	508	
PCD21	Pier cap - flat decorated - 21"	£46.00	36	80	533	533	
PCD22	Pier cap - flat decorated - 22"	£52.00	41	76	559	559	
PCD23	Pier cap - flat decorated - 23"	£60.00	45	78	584	584	
PCD24	Pier cap - flat decorated - 24"	£62.00	48	76	610	610	
PCD27	Pier cap - flat decorated - 27"	£86.00	82	102	686	686	
PCD30	Pier cap - flat decorated - 30"	£106.00	101	102	762	762	
PC06	Pier cap - flat decorated - 32"	£125.00	147	127	823	823	
PC07	Pier cap - flat decorated - 36"	£170.00	172	127	914	914	

Page 4.7

PCT8	Pier cap - weathered - 8"	£11.00	3	64	203	203	
PCT10	Pier cap - weathered - 10"	£14.00	6	76	254	254	
PCT12	Pier cap - weathered - 12"	£18.00	11	102	311	311	
PCT14	Pier cap - weathered - 14"	£22.00	15	102	359	359	

Appendix

Code	Name	Price Excl. VAT	Weight (Kg)	Height (mm)	Width/ length 1	Width/ length 2	Comments
PCT16	Pier cap - weathered - 16"	£28.00	24	127	406	406	
PCT18	Pier cap - weathered - 18"	£36.00	30	127	457	457	
PCT20	Pier cap - weathered - 20"	£44.00	37	127	508	508	
PCT22	Pier cap - weathered - 22"	£60.00	53	152	559	559	
PCT24	Pier cap - weathered - 24"	£65.00	64	152	610	610	
PCT27	Pier cap - weathered - 27"	£85.00	70	152	686	686	
PCT30	Pier cap - weathered - 30"	£115.00	95	178	762	762	
PCT35	Pier cap - weathered - 35"	£145.00	110	191	881	881	
PCT36	Pier cap - weathered - 36"	£165.00	120	204	915	915	
PCT37	Pier cap - weathered - 37"	£165.00	120	162	940	940	Not illustrated

Page 4.8

PCWD12	Pier cap - weathered decorated - 12"	£30.00	12	102	311	311	
PCT14	Pier cap - weathered - 14"	£22.00	15	102	359	359	
UP05C	Classical Plinth - cap	£21.28	13	66	330	330	
PCWD16	Pier cap - weathered decorated - 16"	£38.00	21	102	406	406	
PCT16	Pier cap - weathered - 16"	£28.00	24	127	406	406	
UP05C	Classical Plinth - cap	£21.28	13	66	330	330	
PCT18	Pier cap - weathered - 18"	£36.00	30	127	457	457	
PCD16	Pier cap - flat decorated - 16"	£30.00	18	64	406	406	
PCT24	Pier cap - weathered - 24"	£65.00	64	152	610	610	
PCD22	Pier cap - flat decorated - 22"	£52.00	41	76	559	559	
PCT30	Pier cap - weathered - 30"	£115.00	95	178	762	762	
PCD27	Pier cap - flat decorated - 27"	£86.00	82	102	686	686	
PCT35	Pier cap - weathered - 35"	£145.00	110	191	881	881	
PCD30	Pier cap - flat decorated - 30"	£106.00	101	102	762	762	
PCT36	Pier cap - weathered - 36"	£165.00	120	204	915	915	
PC06	Pier cap - flat decorated - 32"	£125.00	147	127	823	823	

Page 4.9

PCB10	Pier cap - plain - 10"	£11.00	6	51	254	254	
PCH18	Pier cap - half weathered - 18"	£44.00	34	101	457	457	

Appendix

Code	Name	Price Excl. VAT	Weight (Kg)	Height (mm)	Width/ length 1	Width/ length 2	Comments
PCD16	Pier cap - flat decorated - 16"	£30.00	18	64	406	406	
PCB14	Pier cap - plain - 14"	£16.00	15	64	356	356	
PCH24	Pier cap - half weathered - 24"	£70.00	62	102	610	610	
PCD22	Pier cap - flat decorated - 22"	£52.00	41	76	559	559	
PCB18	Pier cap - plain - 18"	£26.00	24	64	457	457	
PCH30	Pier cap - half weathered - 30"	£110.00	97	102	762	762	
PCD27	Pier cap - flat decorated - 27"	£86.00	82	102	686	686	
PCB24	Pier cap - plain - 24"	£50.00	51	76	610	610	
PCH36	Pier cap - half weathered - 36"	£140.00	140	102	915	915	
PC06	Pier cap - flat decorated - 32"	£125.00	147	127	823	823	
<i>Page 4.10</i>							
F170	17" Ball only	£81.70	80	432	432	432	
PCD22	Pier cap - flat decorated - 22"	£52.00	41	76	559	559	
PCB16	Pier cap - plain - 16"	£22.00	19	64	406	406	
F090	9" Ball only	£32.34	12	229	229	229	
PCB20	Pier cap - plain - 20"	£30.00	35	76	508	508	
F092	Round Base only	£20.43	4	152	178	178	
F120	12" Ball only	£45.96	30	301	305	305	
F121	Square Base (9") only	£19.57	16	254	229	229	
PCB16	Pier cap - plain - 16"	£22.00	19	64	406	406	
PCD22	Pier cap - flat decorated - 22"	£52.00	41	76	559	559	
<i>Page 4.11</i>							
F170	17" Ball only	£81.70	80	432	432	432	
F171	Square Base (14") Only	£42.55	32	330	356	356	
PCB20	Pier Cap - Plain - 20"	£30.00	35	76	508	508	
PCB24	Pier Cap - Plain - 24"	£50.00	51	76	610	610	

Appendix

Code	Name	Price Excl. VAT	Weight (Kg)	Height (mm)	Width/ length 1	Width/ length 2	Comments
F120	12" Ball Only	£45.96	30	301	305	305	
F121	Square Base (9") Only	£19.57	16	254	229	229	
PCB16	Pier Cap - Plain - 16"	£22.00	19	64	406	406	
PCB22	Pier Cap - Plain - 22"	£40.00	43	76	559	559	
PCD27	Pier Cap - Flat Decorated - 27"	£86.00	82	102	686	686	
SC10/552	Pier String Course - 552mm	£42.00	22	65	552	552	
F090	9" Ball Only	£32.34	12	229	229	229	
F093	Sloping Base Only	£22.13	28	279	356	356	
PCP24	Pier Cap - Part Weathered - 24"	£60.00	48	76	610	610	
SC10/552	Pier String Course - 552mm	£42.00	22	65	552	552	
<i>Page 4.12</i>							
F170	17" Ball Only	£81.70	80	432	432	432	
F171	Square Base (14") Only	£42.55	32	330	356	356	
PCB24	Pier Cap - Plain - 24"	£50.00	51	76	610	610	
PCH36	Pier Cap - Half Weathered - 36"	£140.00	140	102	915	915	
PC06	Pier Cap - Flat Decorated - 32"	£125.00	147	127	823	823	
F170	17" Ball Only	£81.70	80	432	432	432	
PCB24	Pier Cap - Plain - 24"	£50.00	51	76	610	610	
PCB30	Pier Cap - Plain - 30"	£72.00	79	76	762	762	
F002	Pineapple and Base	£161.70	104	889	508	508	
PCB24	Pier Cap - Plain - 24"	£50.00	51	76	610	610	
PC06	Pier Cap - Flat Decorated - 32"	£125.00	147	127	823	823	
SC10/665	Pier String Course - 665mm	£52.00	27	65	665	665	
<i>Page 4.13</i>							
GP50	Gate Pier as illustrated (inc. cap UP09C)	£367.40	360	2,029	584	584	

Appendix

Code	Name	Price Excl. VAT	Weight (Kg)	Height (mm)	Width/ length 1	Width/ length 2	Comments
GP51	Gate Pier - Plinth	£57.20	52	163	584	584	
GP52	Gate Pier - Shaft	£88.00	90	588	398	398	
UP09C	Victorian Pedestal - Cap	£46.81	38	78	584	584	
GP30	Gate Pier as illustrated (inc. cap UP04C)	£261.80	186	1,563	536	536	
GP31	Gate Pier - Plinth	£55.00	30	100	536	536	
GP32	Gate Pier - Shaft	£55.00	45	453	364	364	
UP04C	Panelled Pedestal - Cap	£38.30	36	88	480	480	
GP40	Gate Pier as illustrated (inc. cap UP09C)	£354.20	305	2,121	584	584	
GP41	Gate Pier - Plinth	£57.20	52	163	584	584	
GP42	Gate Pier - Shaft Top/Bottom	£99.00	90	775	405	405	
GP43	Gate Pier - Shaft	£57.20	35	300	405	405	
UP09C	Victorian Pedestal - Cap	£46.81	38	78	584	584	
<i>Page 4.14</i>							
GP10	Gate Pier as illustrated (inc. cap PCD22)	£605.00	590	2,328	623	623	
GP11	Gate Pier - Plinth (4 Casts)	£82.50	59	152	623	623	
GP12	Gate Pier - Shaft Base	£66.00	70	300	483	483	
GP13	Gate Pier - Shaft	£66.00	70	300	483	483	
GP14	Gate Pier - Shaft Top	£66.00	70	300	483	483	
PCD24	Pier Cap - Flat Decorated - 24"	£62.00	48	76	610	610	
GP20	Gate Pier as illustrated (inc. cap PCD27)	£781.00	900	2,654	699	699	
GP21	Gate Pier - Plinth (4 Casts)	£88.00	66	152	699	699	
GP22	Gate Pier - Shaft Base	£77.00	94	300	559	559	
GP23	Gate Pier - Shaft	£77.00	94	300	559	559	
GP24	Gate Pier - Shaft Top	£77.00	94	300	559	559	
PCD27	Pier Cap - Flat Decorated - 27"	£86.00	82	102	686	686	
<i>Page 4.15</i>							
GP70	Gate Pier as illustrated (inc. pier cap)	£990.00	773	2,130	900	700	

Appendix

Code	Name	Price Excl. VAT	Weight (Kg)	Height (mm)	Width/ length 1	Width/ length 2	Comments
GP71	Gate Pier - Plinth	£220.00	150	200	900	700	
GP72	Gate Pier - Shaft	£110.00	86	300	600	400	
GP73	Gate Pier - Cap	£110.00	107	130	900	700	
GP80	Gate Pier as illustrated (excl. lower shaft)	£990.00	652	2,274	1,024	1,024	
GP81	Gate Pier Cap	£198.00	110	500	1,024	1,024	
GP82	Gate Pier Shaft	£148.50	117	400	745	745	
GP83	Gate Pier Plinth	£198.00	74	174	1,024	1,024	

Page 4.16

GP61	Gate Pier - Plinth Corner	£48.40	82	450	431	431	
GP62	Gate Pier - Quoin	£27.21	45	294	464	352	
GP63	Pier Cap Cornice - Per Section	£74.80	80	192	802	522	
GP64	Gate Pier - Champhered Block	£9.90	14	294	218	127	
GP65	Gate Pier - Plinth Straight	£48.40	50	450	420	102	

Page 4.17

WB8	Wall Coping - Plain - 8"	£19.80	19	51	203	1,000	
WB10	Wall Coping - Plain - 10"	£21.45	23	51	254	1,000	
WB12	Wall Coping - Plain - 12"	£23.10	28	51	305	1,000	
WB14	Wall Coping - Plain - 14"	£25.85	41	64	356	1,000	
WB16	Wall Coping - Plain - 16"	£28.60	46	64	406	1,000	
WB18	Wall Coping - Plain - 18"	£33.00	52	64	457	1,000	
WB20	Wall Coping - Plain - 20"	£42.90	69	76	508	1,000	
WB22	Wall Coping - Plain - 22"	£51.70	76	76	559	1,000	
WB24	Wall Coping - Plain - 24"	£55.00	83	76	610	1,000	
WP8	Wall Coping - Part Weathered - 8"	£20.35	16	51	203	1,000	
WP10	Wall Coping - Part Weathered - 10"	£22.00	21	51	254	1,000	
WP12	Wall Coping - Part Weathered - 12"	£24.75	26	51	305	1,000	
WP14	Wall Coping - Part Weathered - 14"	£27.50	39	64	356	1,000	

Appendix

Code	Name	Price Excl. VAT	Weight (Kg)	Height (mm)	Width/ length 1	Width/ length 2	Comments
WP16	Wall Coping - Part Weathered - 16"	£33.00	44	64	406	1,000	
WP18	Wall Coping - Part Weathered - 18"	£35.75	50	64	457	1,000	
WP20	Wall Coping - Part Weathered - 20"	£46.20	66	76	508	1,000	
WP22	Wall Coping - Part Weathered - 22"	£56.10	73	76	559	1,000	
WP24	Wall Coping - Part Weathered - 24"	£59.40	80	76	610	1,000	

Page 4.18

WO8	Wall Coping - Once Weathered - 8"	£20.90	22	68	203	1,000	
WO10	Wall Coping - Once Weathered - 10"	£22.50	27	68	254	1,000	
WO12	Wall Coping - Once Weathered - 12"	£25.30	33	68	305	1,000	
WO14	Wall Coping - Once Weathered - 14"	£28.60	41	76	356	1,000	
WO16	Wall Coping - Once Weathered - 16"	£35.20	51	76	406	1,000	
WO18	Wall Coping - Once Weathered - 18"	£40.70	52	76	457	1,000	
WO20	Wall Coping - Once Weathered - 20"	£50.60	70	89	508	1,000	
WO22	Wall Coping - Once Weathered - 22"	£59.40	77	89	559	1,000	
WO24	Wall Coping - Once Weathered - 24"	£63.80	84	89	610	1,000	

WT8	Wall Coping - Twice Weathered - 8"	£21.45	19	64	203	1,000	
WT10	Wall Coping - Twice Weathered - 10"	£24.20	26	76	254	1,000	
WT12	Wall Coping - Twice Weathered - 12"	£27.50	49	124	311	1,000	
WT14	Wall Coping - Twice Weathered - 14"	£30.80	40	73	359	1,000	
WT16	Wall Coping - Twice Weathered - 16"	£38.50	46	76	406	1,000	
WT18	Wall Coping - Twice Weathered - 18"	£41.80	52	76	457	1,000	
WT20	Wall Coping - Twice Weathered - 20"	£52.80	58	76	508	1,000	
WT22	Wall Coping - Twice Weathered - 22"	£61.60	77	89	559	1,000	
WT24	Wall Coping - Twice Weathered - 24"	£68.20	91	102	610	1,000	

Page 4.19

WF8	Wall Coping - Flat Decorated - 8"	£21.45	18	51	203	1,000	
WF10	Wall Coping - Flat Decorated - 10"	£24.20	22	51	254	1,000	

Appendix

Code	Name	Price Excl. VAT	Weight (Kg)	Height (mm)	Width/ length 1	Width/ length 2	Comments
WF12	Wall Coping - Flat Decorated - 12"	£27.50	27	51	305	1,000	
WF14	Wall Coping - Flat Decorated - 14"	£30.80	39	64	356	1,000	
WF16	Wall Coping - Flat Decorated - 16"	£38.50	44	64	406	1,000	
WF18	Wall Coping - Flat Decorated - 18"	£41.80	50	64	457	1,000	
WF20	Wall Coping - Flat Decorated - 20"	£52.80	66	76	508	1,000	
WF22	Wall Coping - Flat Decorated - 22"	£61.60	73	76	559	1,000	
WF24	Wall Coping - Flat Decorated - 24"	£68.20	79	76	610	1,000	
WD8	Wall Coping -2 Weathered/Decorated - 8"	£23.10	18	64	203	1,000	
WD10	Wall Coping -2 Weathered/Decorated - 10"	£26.40	25	76	254	1,000	
WD12	Wall Coping -2 Weathered/Decorated - 12"	£29.70	47	124	311	1,000	
WD14	Wall Coping -2 Weathered/Decorated - 14"	£35.20	38	73	359	1,000	
WD16	Wall Coping -2 Weathered/Decorated - 16"	£39.60	44	76	406	1,000	
WD18	Wall Coping -2 Weathered/Decorated - 18"	£44.00	50	76	457	1,000	
WD20	Wall Coping -2 Weathered/Decorated - 20"	£55.00	55	76	508	1,000	
WD22	Wall Coping -2 Weathered/Decorated - 22"	£63.80	73	89	559	1,000	
WD24	Wall Coping -2 Weathered/Decorated - 24"	£72.60	87	102	610	1,000	
<i>Page 4.20</i>							
WCG1	Wall Coping - Gothic	£49.50	37	162	300	800	
WCG2	Wall Coping - Rail	£28.60	21	108	190	800	
WCG3	Wall Coping - Ridged	£33.00	34	175	250	878	
WCG4	Wall Under Coping	£68.20	88	150	500	878	Use with WCG3
<i>Page 4.21</i>							
WCG1	Wall Coping - Gothic	£49.50	37	162	300	800	
WP11	Wall Plinth (Half)	£44.00	46	174	247	1,000	
BS31	Gothic Quatrefoil Only	£79.20	64	552	183	552	
GP80	<i>See page 4.15</i>						